

Study question 3: Update on pink and chum salmon hatchery/wild relative fitness



Kyle Shedd
Gene Conservation Laboratory
Alaska Department of Fish and Game
Alaska Board of Fisheries Hatchery Committee
March 7, 2020

Alaska Hatchery Research Program

- 1) What is the genetic structure of pink and chum in PWS and SEAK?
- 2) What is the extent and annual variability of straying?
- 3) What is the impact on fitness (productivity) of natural pink and chum stocks due to straying hatchery pink and chum salmon?

Hatchery/Natural Fitness

Steelhead

433

Differential reproductive success of sympatric, naturally spawning hatchery and wild steelhead trout (*Oncorhynchus mykiss*) through the adult stage

Jennifer E. McLean, Paul Bentzen, and Thomas P. Quinn

MOLECULAR ECOLOGY

Molecular Ecology (2011) 20, 1860–1869

doi: 10.1111/j.1365-294X.2011.02684.x

Reduced reproductive success of hatchery coho salmon in the wild: insights into most likely mechanisms

Véronique Thériault,¹ Gregory R. Moyer,^{1*} Laura S. Jackson,¹ Michael S. Blouin¹ and Michael A. Banks²

Genetic Effects of Captive Breeding Cause a Rapid, Cumulative Fitness Decline in the Wild

Hitoshi Araki,¹ Becky Cooper, Michael S. Blouin

Publicly every year (1.8). Although most of these hatchery programs are meant to produce fish for harvest, an increasing number of captive breeding programs are releasing fish to restore declining natural populations (1, 2). Hatchery fish bred in the wild and mixed populations are affected by hatchery fish. The use of hatchery-reared fish as broodstock (parents of hatchery fish) for many generations has resulted in indi-

Molecular Ecology (2007) 16, 955–966

doi: 10.1111/j.1365-294X.2006.01236.x

Effective population size of steelhead trout: influence of variance in reproductive success, hatchery programs, and genetic compensation between life-history forms

Hitoshi Araki,¹ Robin S. Waples,¹ William A. Arden,² Becky Cooper¹ and Michael S. Blouin^{1*}

biology letters

Biol. Lett. (2009) 5, 631–634
doi:10.1098/rsbl.2009.0315
Published online 10 June 2009

Carry-over effect of captive breeding reduces reproductive fitness of wild-born descendants in the wild

Hitoshi Araki¹, Becky Cooper and Michael S. Blouin

with captive-bred organisms (supplementation) are not clear yet.

Any negative effects of captive breeding are especially relevant for salmonid species because of the worldwide decline of native salmonid populations and the large scale of hatchery programmes to compensate for those losses. Firstly, there is scant evidence that adding captive-bred organisms has boosted the long-term productivity of wild salmonid populations (Fraser 2008). Secondly, supplementation of declining wild populations entails risks such as disease introduction, increased competition for resources, and genetic changes in the supplemented population (Waples & Drake 2004). The genetic risk results because artificial environments can select for captive-bred individuals that are maladapted to the natural environment (hereafter 'the wild'). For example, genetically-based

Transactions of the American Fisheries Society
Publication details, including instructions for authors and subscription information:
<http://www.tandfonline.com/doi/10.1111/j.1548-8659.2011.02011.x>

Diminished Reproductive Success of Steelhead from a Hatchery Supplementation Program (Little Sheep Creek, Imnaha Basin, Oregon)

Ewan A. Berntson¹, Richard W. Carmichael², Michael V. Fluehr³, Eric J. Vitarek⁴ & Paul Moran¹

Genetic adaptation to captivity can occur in a single generation

Mark R. Christie^{1*}, Manián L. Martínez¹, Rod A. French², and Michael S. Blouin¹

¹Department of Zoology, Oregon State University, Corvallis, OR 97331-2914, and ²Oregon Department of Fish and Wildlife, The Dalles, OR 97008-0348
Edited by Mark R. Christie, University of Minnesota, Minnesota, USA, and accepted by the Editorial Board on 11 July 2011 (received first version 20 June 2011; accepted version 20 June 2011)
Captive breeding programs are widely used for the conservation and restoration of threatened and endangered species. Nevertheless, captive-born individuals frequently have reduced fitness when

have a high standing mutational load or spend many generations in captivity (3). Unintentional domestication selection, on the other hand, can rapidly reduce fitness in the wild, especially if

Chinook

[Article]

North American Journal of Fisheries Management 2012, 32(5): 1485–1500
© Copyright by the American Fisheries Society 2008
DOI: 10.1577/M07-105.1

Use of Parentage Analysis to Determine Reproductive Success of Hatchery-Origin Spring Chinook Salmon Outplanted into Shilike Creek, Oregon

JASON BAUMSTARK¹

¹U.S. Fish and Wildlife Service, 1440 Abernathy Creek Road, Longview, Washington 9802, USA

DAVID M. HAND² AND DOUGLAS E. OLSON

²U.S. Fish and Wildlife Service, Columbia River Fisheries Program Office, 1211 Southeast Cardinal Court, Suite 100, Vancouver, Washington 98685, USA

ROBERT SPATEROLO³ AND GREG FITZGERALD³

³Confederated Tribes of the Warm Springs Reservation of Oregon, Department of Natural Resources, Warm Springs, Oregon 97149, USA

WILLIAM R. ARDEN⁴

⁴U.S. Fish and Wildlife Service, Astoria Fish Technology Center, 1440 Abernathy Creek Road, Longview, Washington 9802, USA

10.1577/M07-105.1

1840

Factors influencing the relative fitness of hatchery and wild spring Chinook salmon (*Oncorhynchus tshawytscha*) in the Wenatchee River, Washington, USA

Kevin S. Williamson, Andrew R. Murdoch, Todd N. Pearsons, Eric J. Ward, and Michael J. Ford

MOLECULAR ECOLOGY

Molecular Ecology (2012) 21, 5236–5250

doi: 10.1111/mec.12066

Supportive breeding boosts natural population abundance with minimal negative impacts on fitness of a wild population of Chinook salmon

MAUREEN A. HESS,¹ CRAIG D. RABE,¹ JASON L. VOGEL,¹ JEFF J. STEPHENSON,¹ DOUG D. NELSON² and SHAWN R. NARUM^{1*}

Evolutionary Applications

Evolutionary Applications (2012) 5(5), 1722–1731

ORIGINAL ARTICLE

Reproductive success of captive bred and naturally spawned Chinook salmon colonizing newly accessible habitat

Joseph H. Anderson,^{1,2,3*} Paul L. Faulstich,¹ William I. Atlas^{1,4} and Thomas P. Quinn¹

¹School of Aquatic and Fishery Sciences, University of Washington Seattle, WA, USA

²Seattle Public Utilities, Seattle, WA, USA

³Present address: Northwest Fisheries Science Center, National Marine Fisheries Service Seattle, WA, USA

⁴Present address: Department of Biological Sciences, Simon Fraser University Burnaby, BC, Canada

Keywords: conservation, dams, hatchery, natural selection, pedigree, restoration, sexual selection

*Correspondence: Joseph H. Anderson, Northwest Fisheries Science Center National Marine Fisheries Service 2725 Montrose Blvd Seattle WA 98112

Tel.: (206) 325 2892

Fax: (206) 860 3796

Email: joeh.anderson@noaa.gov

Received 22 March 2012

Accepted 2 April 2012

doi:10.1111/j.1751-0751.2012.01297.x

Captively reared animals can provide an immediate demographic boost in reintroduction programs, but may also reduce the fitness of colonizing populations. Construction of a fish passage facility at Leaning Diversion Dam on the Cedar River, WA, USA, provided a unique opportunity to explore this trade-off. We thoroughly sampled adult Chinook salmon (*Oncorhynchus tshawytscha*) at the onset of colonization (2003–2009), constructed a pedigree from genotypes at 30 microsatellite loci, and calculated reproductive success (RS) as the total number of returning adult offspring. Hatchery males were consistently but not significantly less productive than naturally spawned males (range in relative RS 0.70–0.90), but the pattern for females varied between years. The sex ratio was heavily biased toward males; therefore, inclusion of the hatchery males increased the ratio of genetic fitness cost with little demographic benefit. Measurements of natural selection indicated that larger salmon had higher RS than smaller fish. Fish that arrived early to the spawning grounds tended to be more productive than later fish, although in some years, RS was maximized in intermediate dates. Our results underscore the importance of natural and selective forces in promoting adapta-

Coho

2943

Changes in run timing and natural smolt production in a naturally spawning coho salmon (*Oncorhynchus kisutch*) population after 60 years of intensive hatchery supplementation

Michael J. Ford, Howard Fuss, Brant Boots, Eric LaHood, Jeffrey Hard, and Jason Miller

MOLECULAR ECOLOGY

Molecular Ecology (2011) 20, 1860–1869

doi: 10.1111/j.1365-294X.2011.02684.x

Reduced reproductive success of hatchery coho salmon in the wild: insights into most likely mechanisms

Véronique Thériault,¹ Gregory R. Moyer,^{1*} Laura S. Jackson,¹ Michael S. Blouin¹ and Michael A. Banks²

¹World Oregon Marine Experiment Station, Hatfield Marine Science Center, Department of Fisheries and Wildlife, Oregon State University, 2000 SE Marine Science Drive, Newport, OR 97135, USA; ²Oregon Department of Fish and Wildlife, 4192 N Unqua Highway, Redding, OR 97470, USA; ³Department of Zoology, 3029 Corvallis Hall, Oregon State University, Corvallis, OR 97331, USA

Abstract

Supplementation of wild salmonids with captive-bred fish is a common practice for both commercial and conservation purposes. However, evidence for lower fitness of captive-reared fish relative to wild fish has accumulated in recent years, diminishing the apparent effectiveness of supplementation as a management tool. To date, the mechanisms responsible for these fitness declines remain unknown. In this study, we showed with molecular parentage analysis that hatchery coho salmon (*Oncorhynchus kisutch*) had lower reproductive success than wild fish once they reproduced in the wild. This effect was more pronounced in males than in same-aged females. Hatchery spawned fish that were released as unfed fry (age 0), as well as hatchery fish raised for one year in the hatchery (released as smolts, age 1), both experienced lower lifetime reproductive success (RS) than wild fish. However, the subset of hatchery males that returned as 2-year olds (age 2) did not exhibit the same fitness decrease as males that returned as 3-year olds. Thus, we report three lines of evidence pointing to the absence of sexual selection in the hatchery as a contributing mechanism for fitness declines of hatchery fish in the wild (0 hatchery fish released as unfed fry that survived to adulthood still had low RS relative to wild fish, 60 age-1 male hatchery fish consistently showed a lower relative RS than female hatchery fish suggesting a role for sexual selection), and (iii) age-2 jacks, which use a weaker mating strategy, did not show the same declines as 3-year olds, which compete differently for females (again, implicating sexual selection).

Keywords: captive breeding, parentage analysis, reproductive success, salmonids, sexual selection, supplementation

Received 20 January 2010; revision received 14 January 2011; accepted 18 January 2011

Chum

781

Reproductive behavior and relative reproductive success of natural- and hatchery-origin Hood Canal summer chum salmon (*Oncorhynchus keta*)

Barry A. Berejikian, Donald M. Van Doornik, Julie A. Scheurer, and Richard Bush

Abstract: Estimates of the relative fitness of hatchery- and natural-origin salmon can help determine the value of hatchery stocks in contributing to recovery efforts. This study compared the adult life cycle reproductive success of natural-origin summer chum salmon (*Oncorhynchus keta*) with that of first- to third-generation hatchery-origin salmon in an experiment that included four replicate breeding groups. Hatchery- and natural-origin chum salmon exhibited similar reproductive success. Hatchery- and natural-origin males obtained similar access to mating females, and females of both types exhibited similar breeding behaviors and duration. Male body size was positively correlated with access to mating females and reproductive success. The estimates of relative reproductive success (hatchery:natural = 0.83) in this study were similar to those in other studies of other anadromous salmonids in which the hatchery population was founded from the local natural population and much higher than those in studies that evaluated the lifetime relative reproductive success of wilder hatchery populations.

Hatchery/Natural Fitness

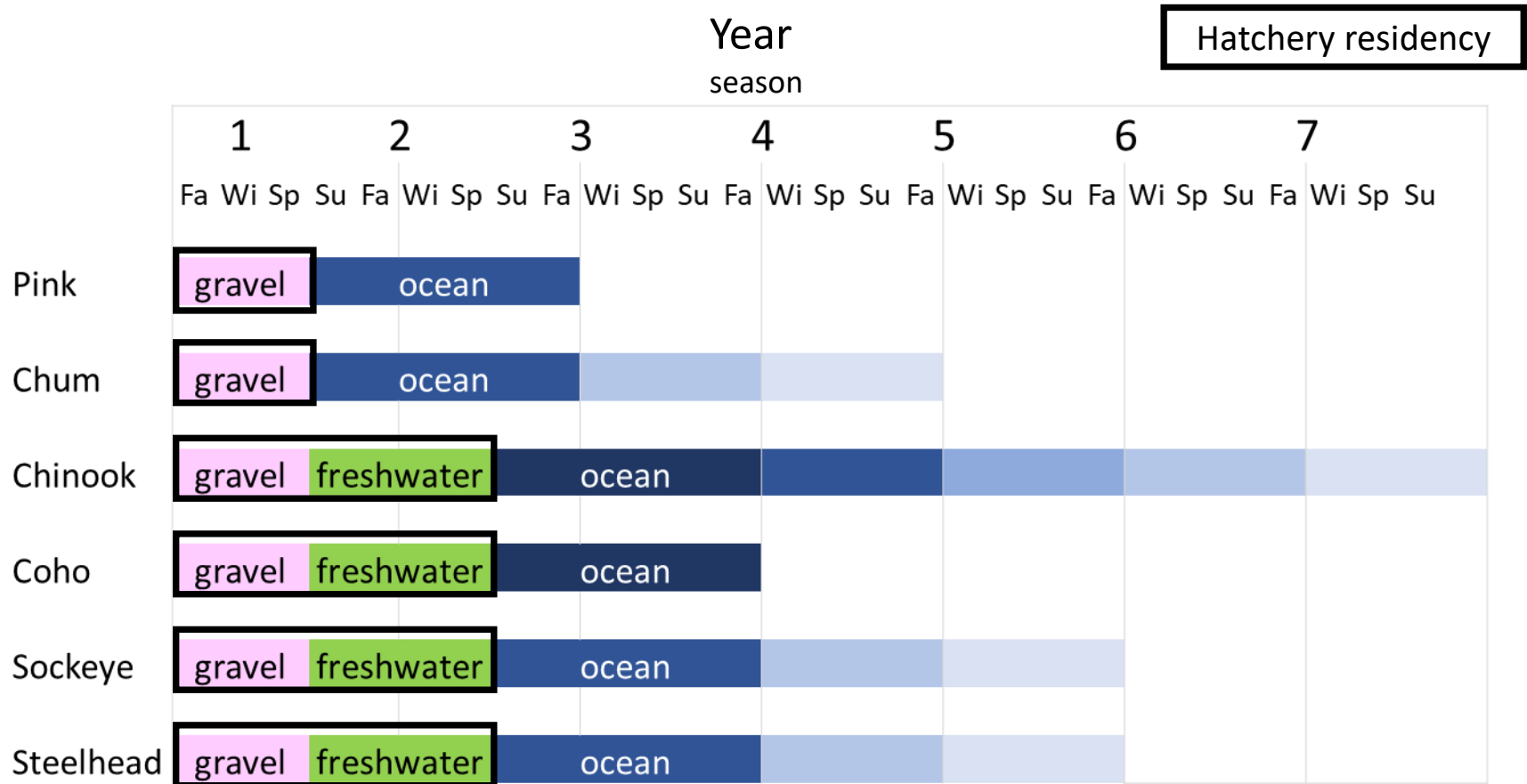

AHRP Fitness Study: PWS Pink Salmon

AHRP Streams in PWS

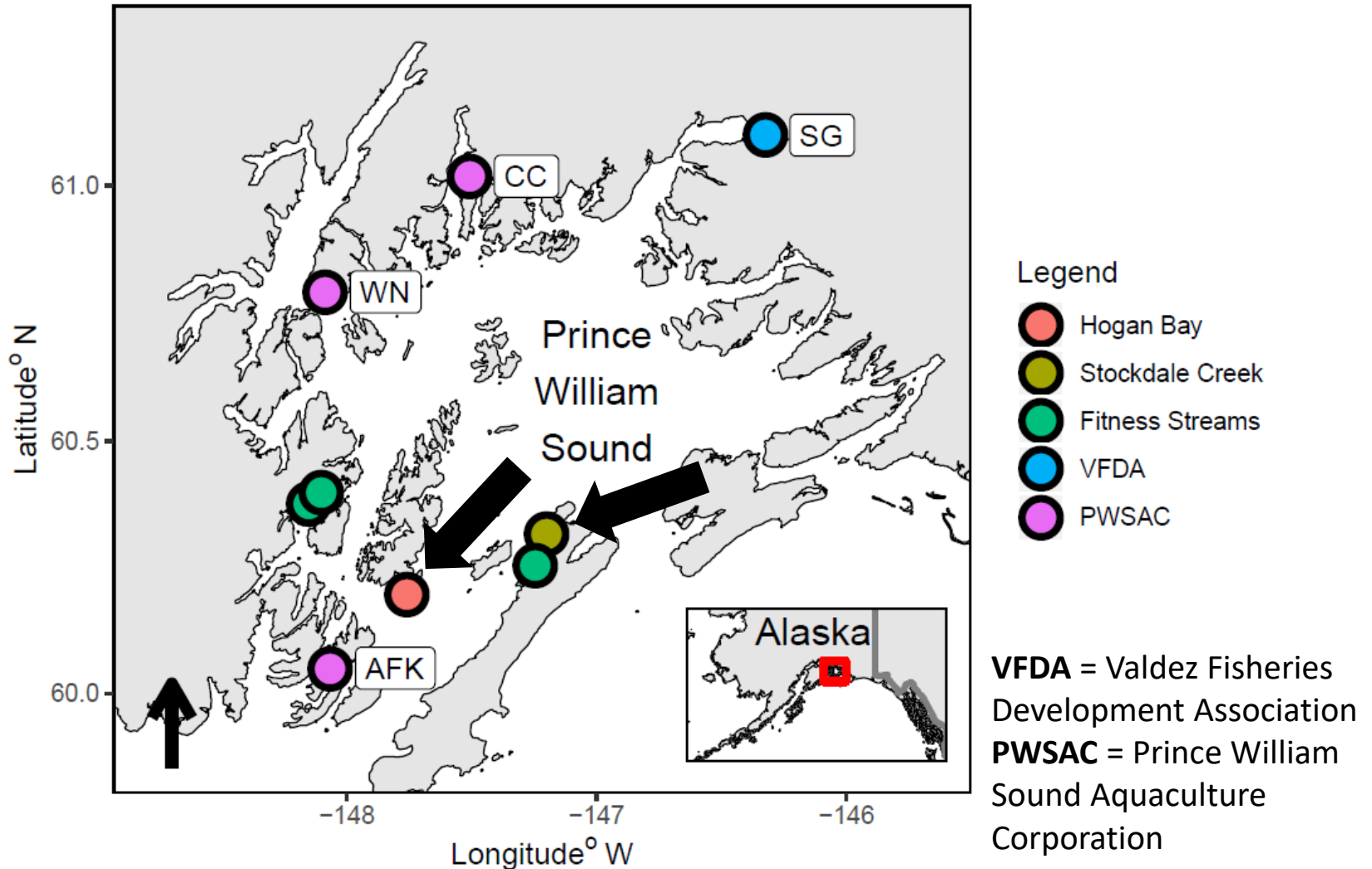

Figure 1 – Lescak et al. *in submission*

AHRP Streams in PWS

Presented last year

Stream	2013	2014	2015	2016	2017	2018	2019
Hogan	P	P	P,O	P,O	P,O,G	O,G	O,G
Stockdale	P	P	P,O	P,O	P,O,G	O,G	O,G

P – parents

O – offspring

G – grand-offspring

Odd-lineage

Even-lineage

Fitness = Reproductive Success

Parent



Measuring Reproductive Success

Parent



Measuring Reproductive Success

Parent

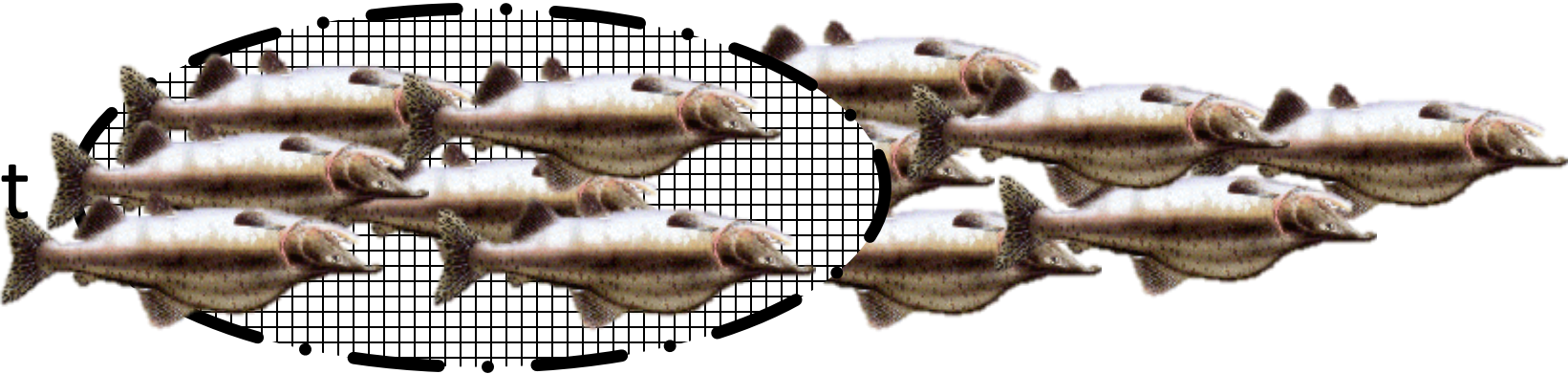

Measuring Reproductive Success

Parent



Measuring Reproductive Success

P

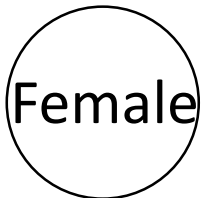
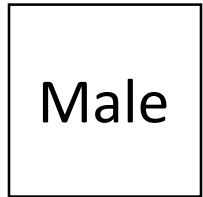
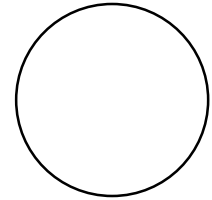
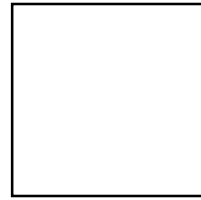
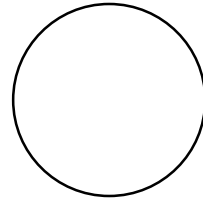
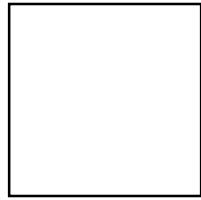
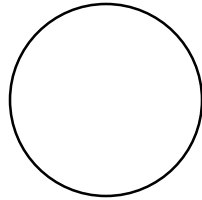
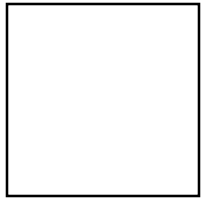

Measuring Reproductive Success

P

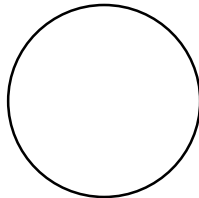
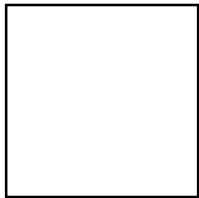
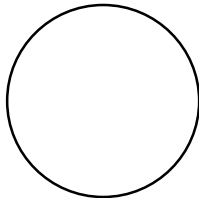
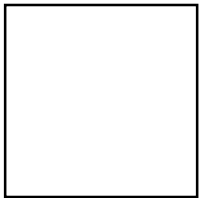
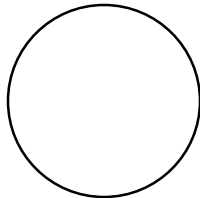
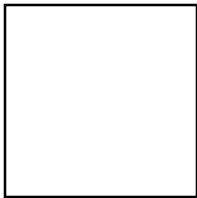

Male

Female

Measuring Reproductive Success

P

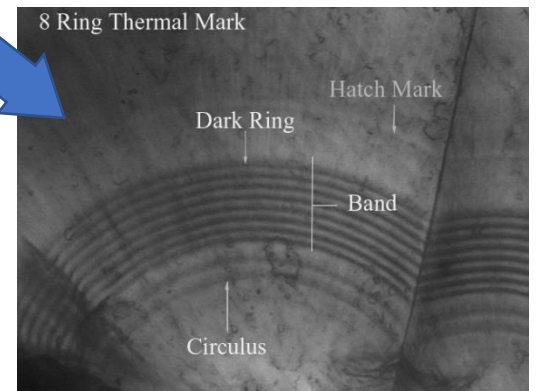
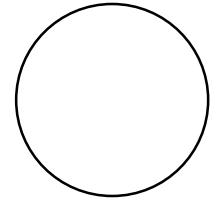
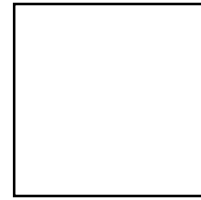
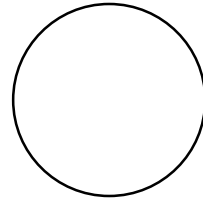
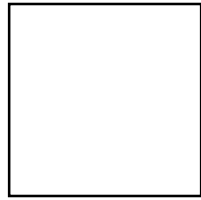
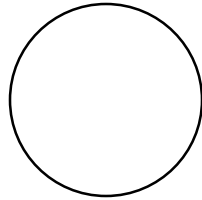
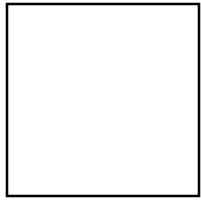

Hatchery-origin

Male

Female

Measuring Reproductive Success

P

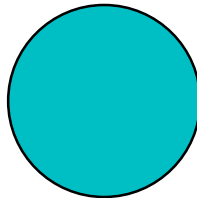
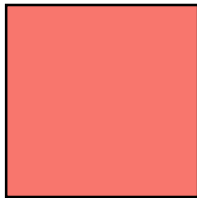
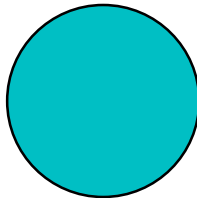
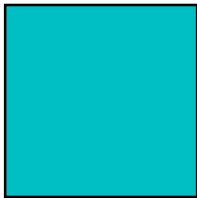
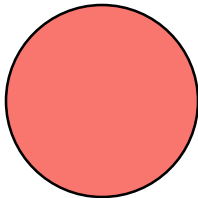
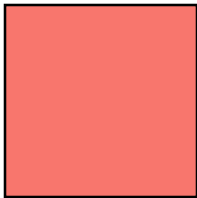

Natural

Hatchery

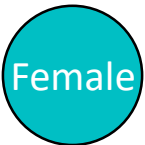
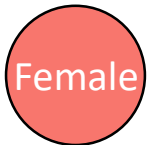

Measuring Reproductive Success

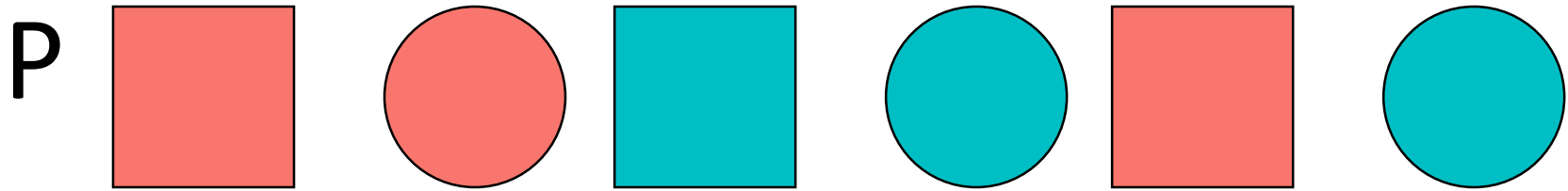

return to stream

O



harvest



Natural Hatchery

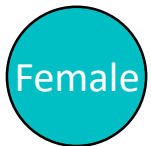
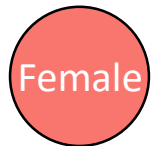
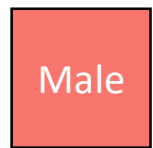

stray



Measuring Reproductive Success

P

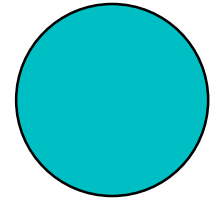
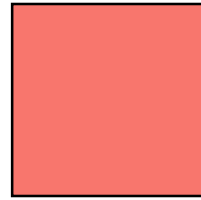
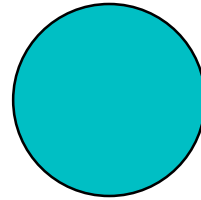
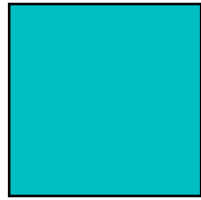
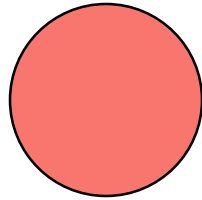
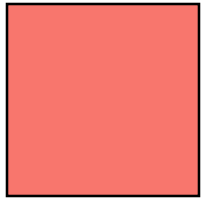

O



Natural

Hatchery

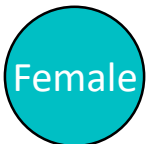
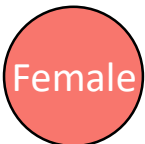
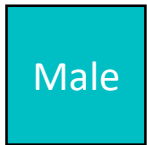

Measuring Reproductive Success

P

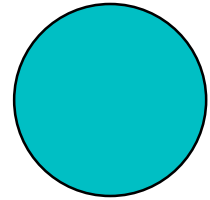
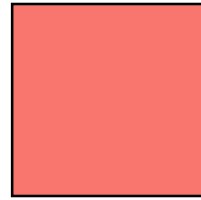
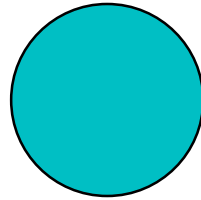
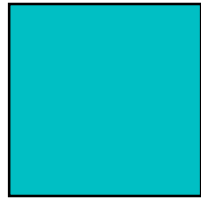
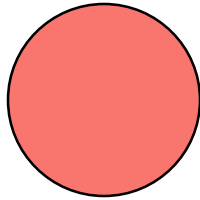
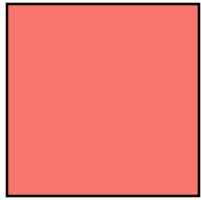

O



Natural

Hatchery

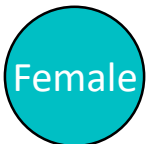
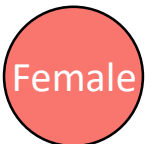
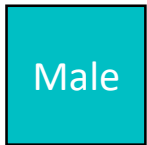

Measuring Reproductive Success

P

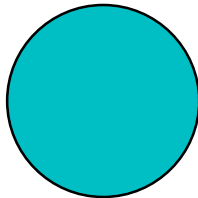
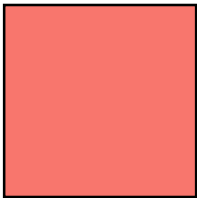
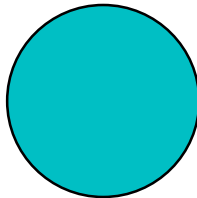
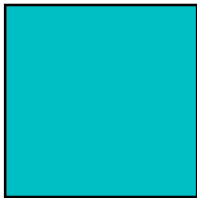
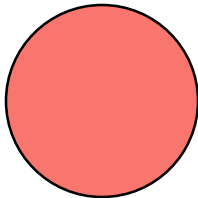
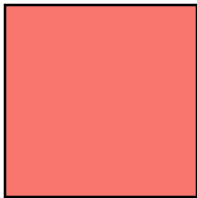

O

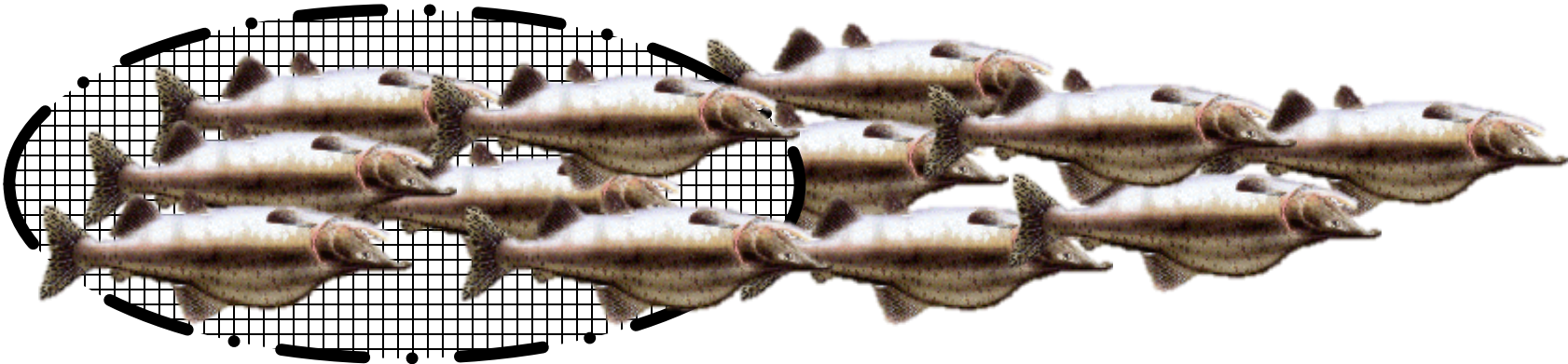

Natural

Hatchery

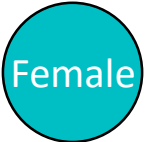
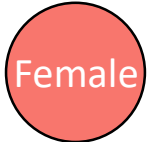

Measuring Reproductive Success

P

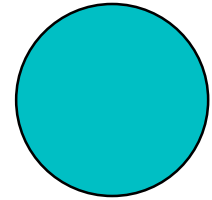
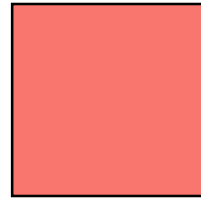
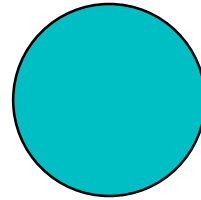
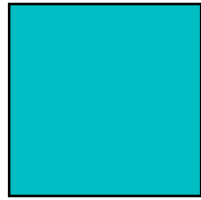
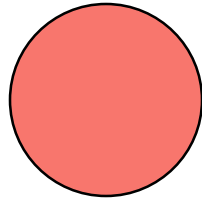
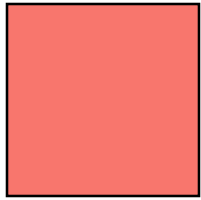

O

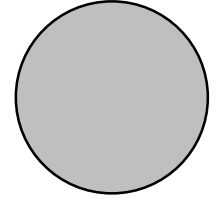
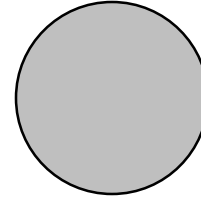
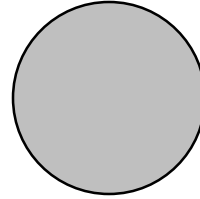
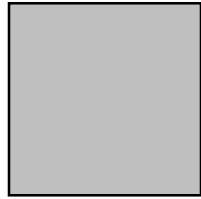
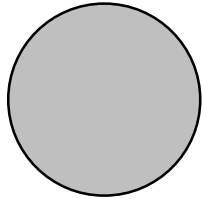

Natural

Hatchery

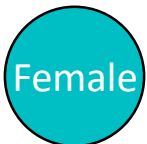
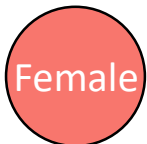
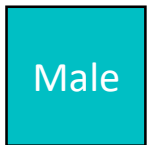

Measuring Reproductive Success

P

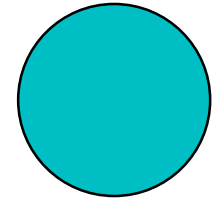
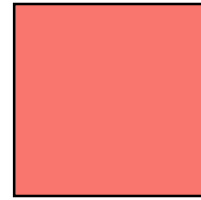
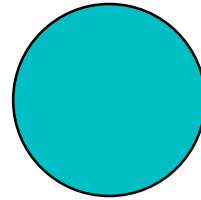
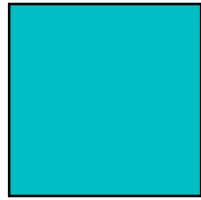
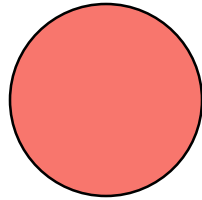
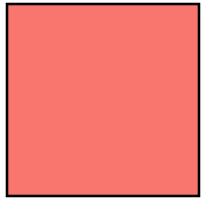

O

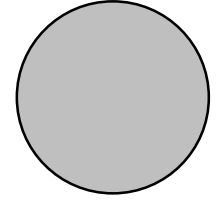
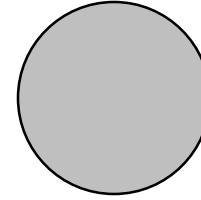
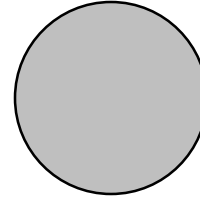
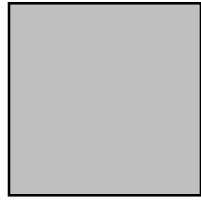
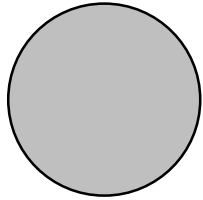

Natural

Hatchery

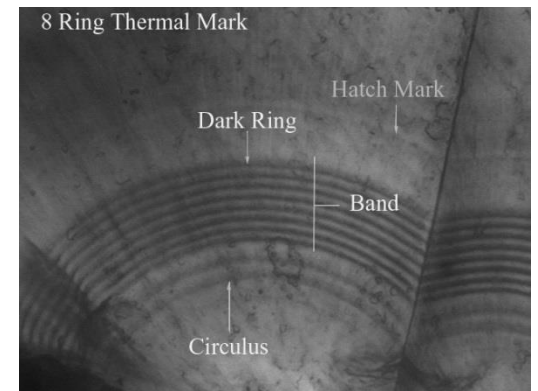
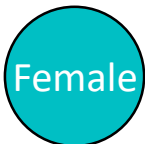
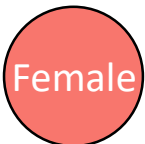
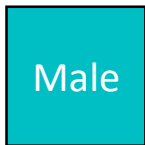

Hatchery-origin

Measuring Reproductive Success

P

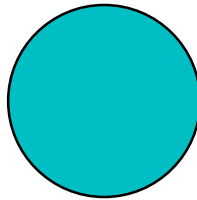
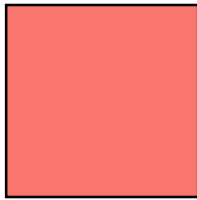
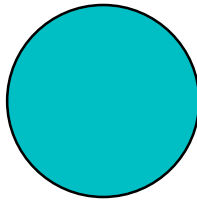
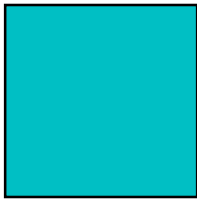
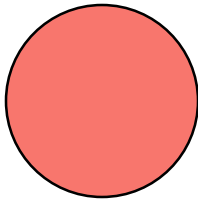
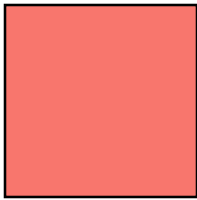

O

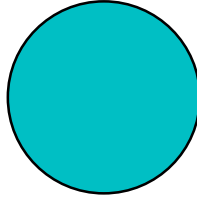
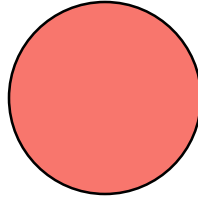
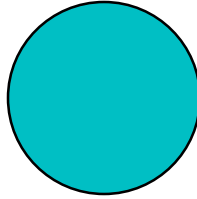
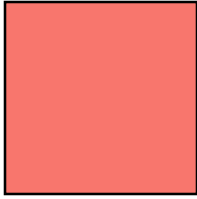
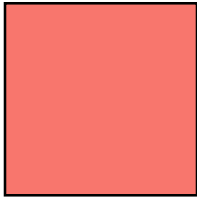
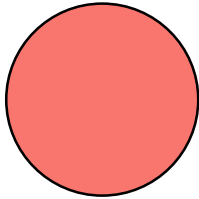

Natural

Hatchery

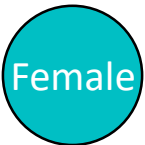
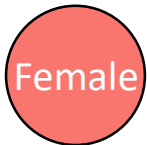
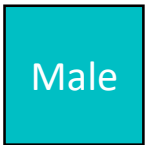

Measuring Reproductive Success

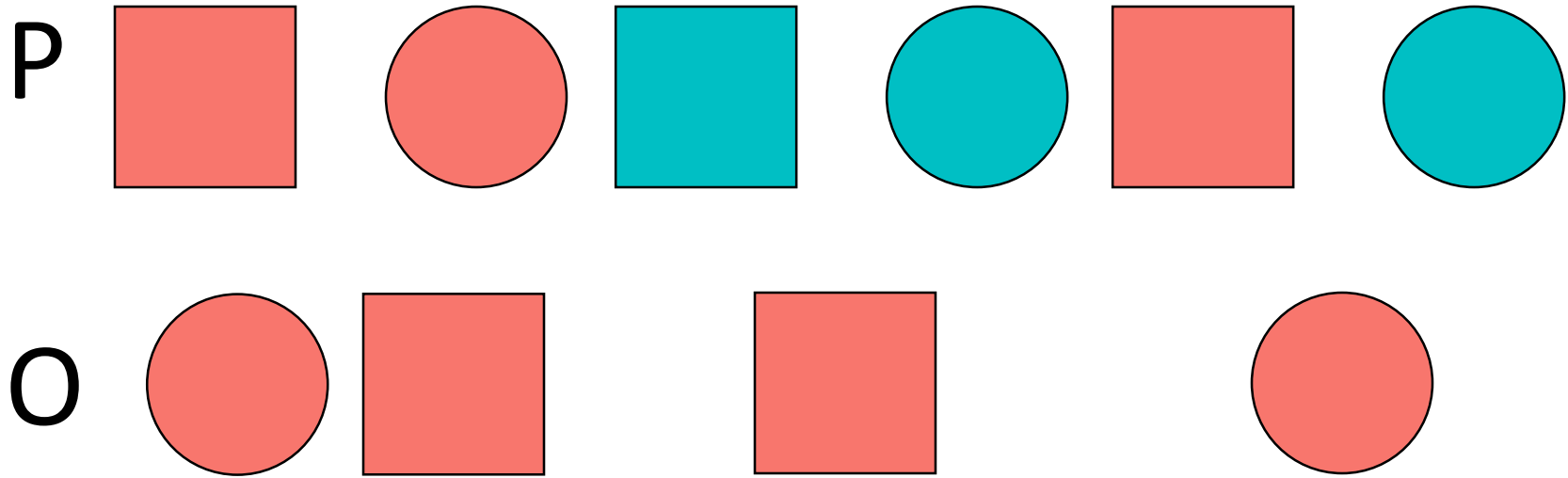

Natural Hatchery

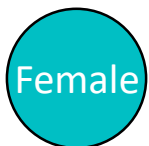
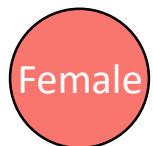
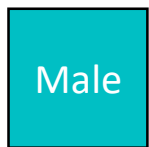
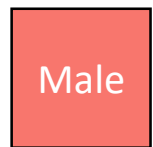

Hatchery-origin fish are not genotyped in the offspring generation because they have a known origin.

Measuring Reproductive Success

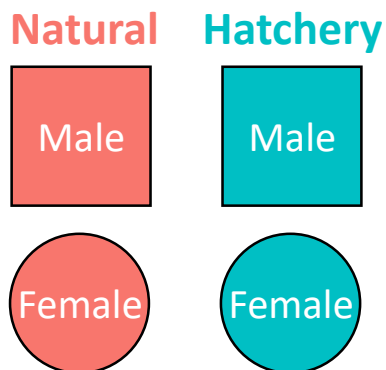
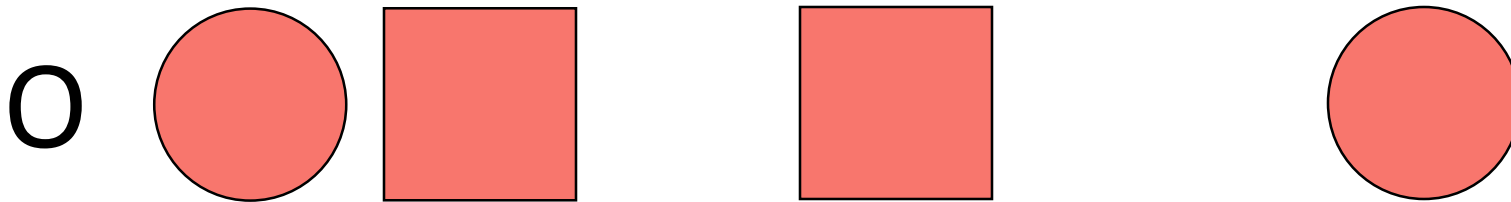
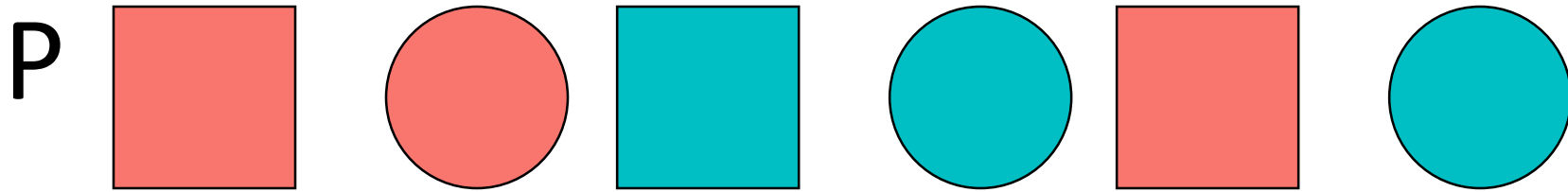

298
markers

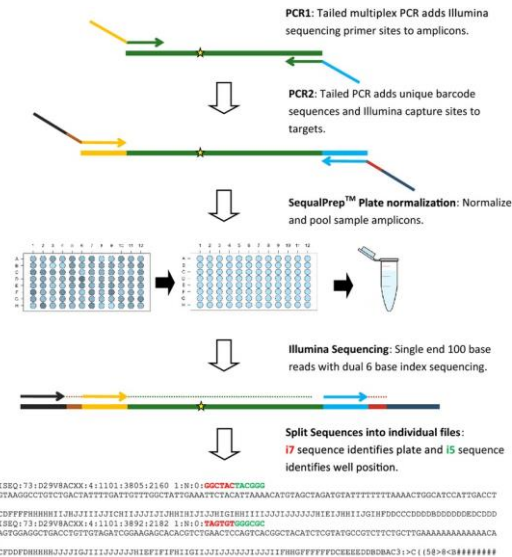

Figure 1 – Campbell et al. 2015

Genetic Parentage Analysis



Genetic Parentage Analysis

Markers



Potential sires (♂)

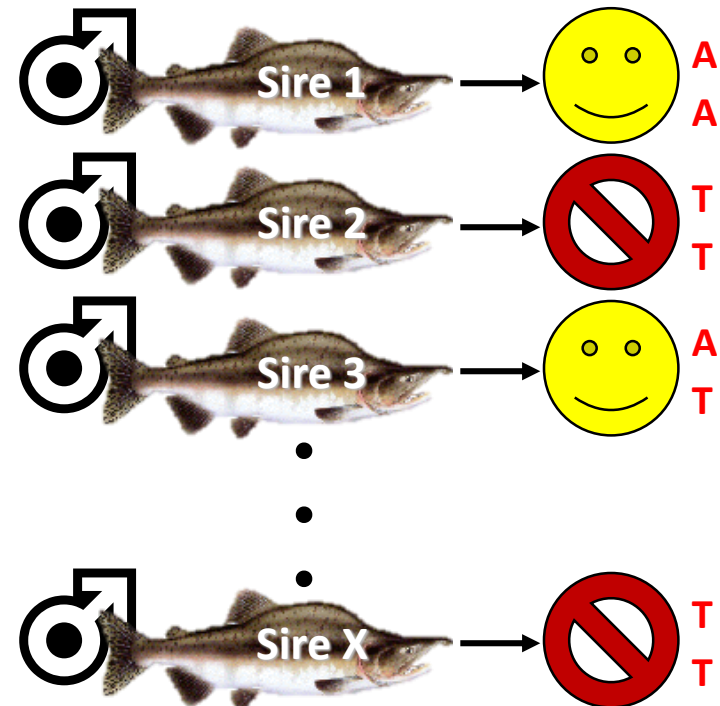

Genetic Parentage Analysis

Markers

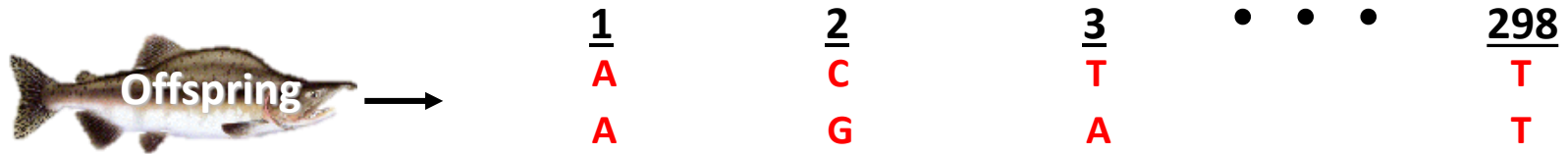

Potential sires (♂)

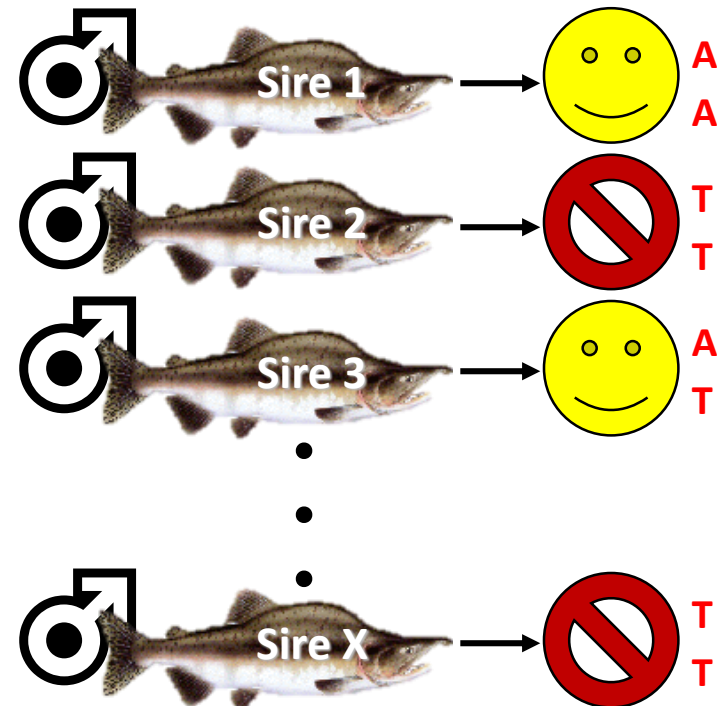

Genetic Parentage Analysis

Markers

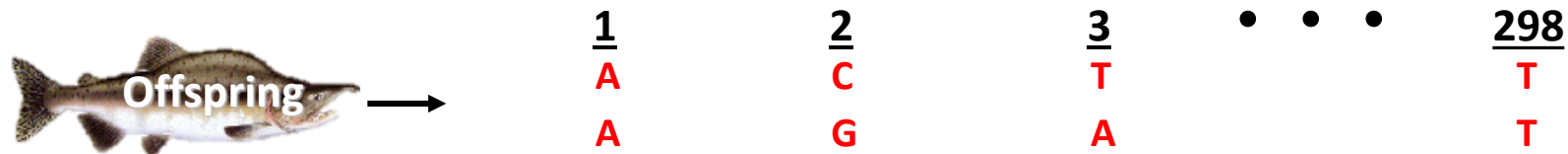

Potential sires (♂)

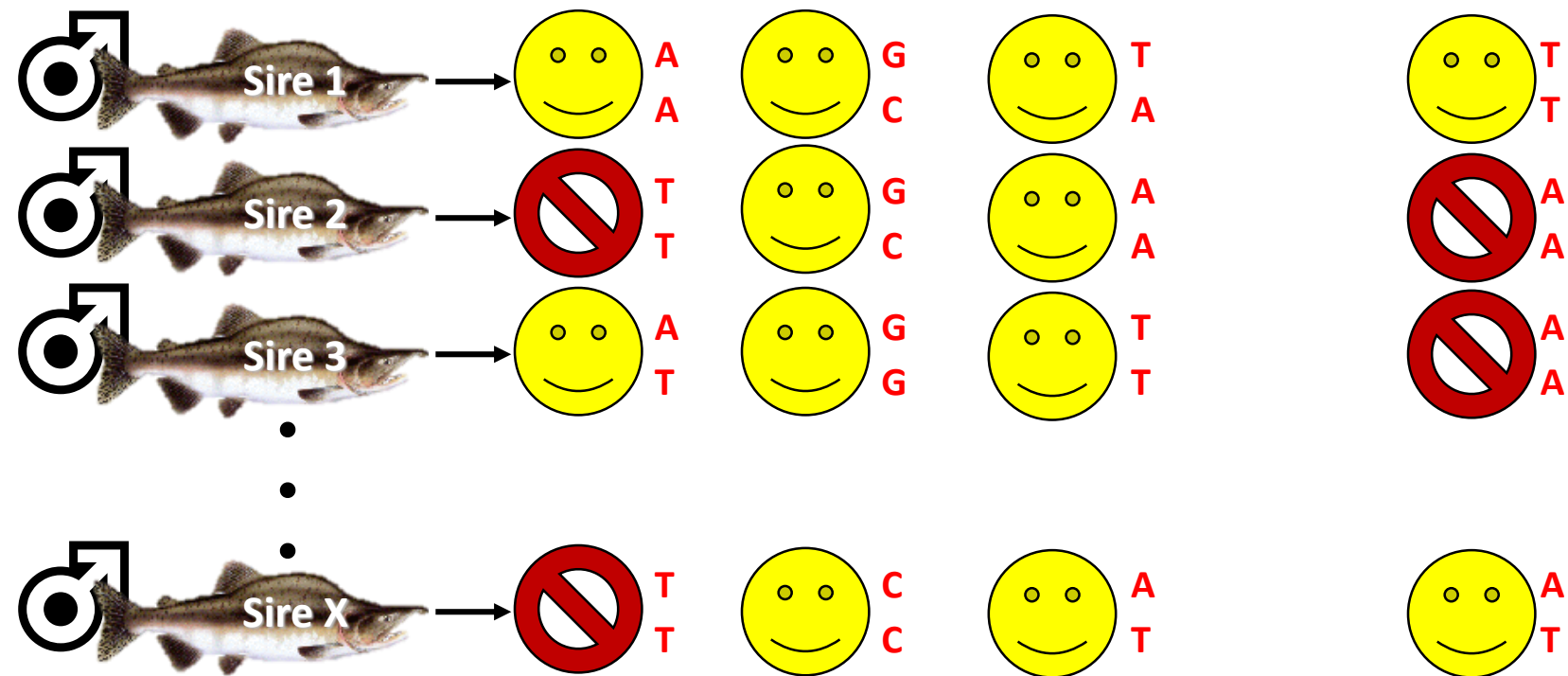

Genetic Parentage Analysis

Markers

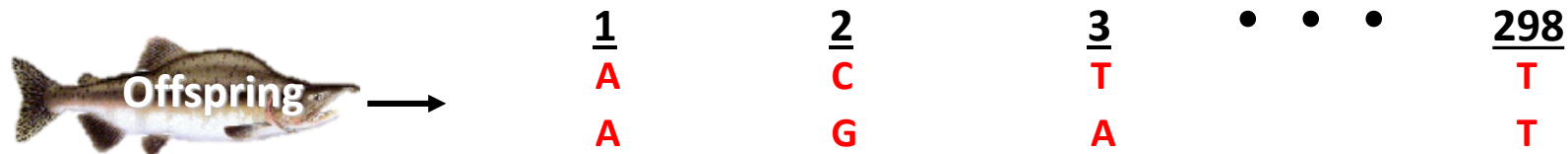

Potential sires (♂)

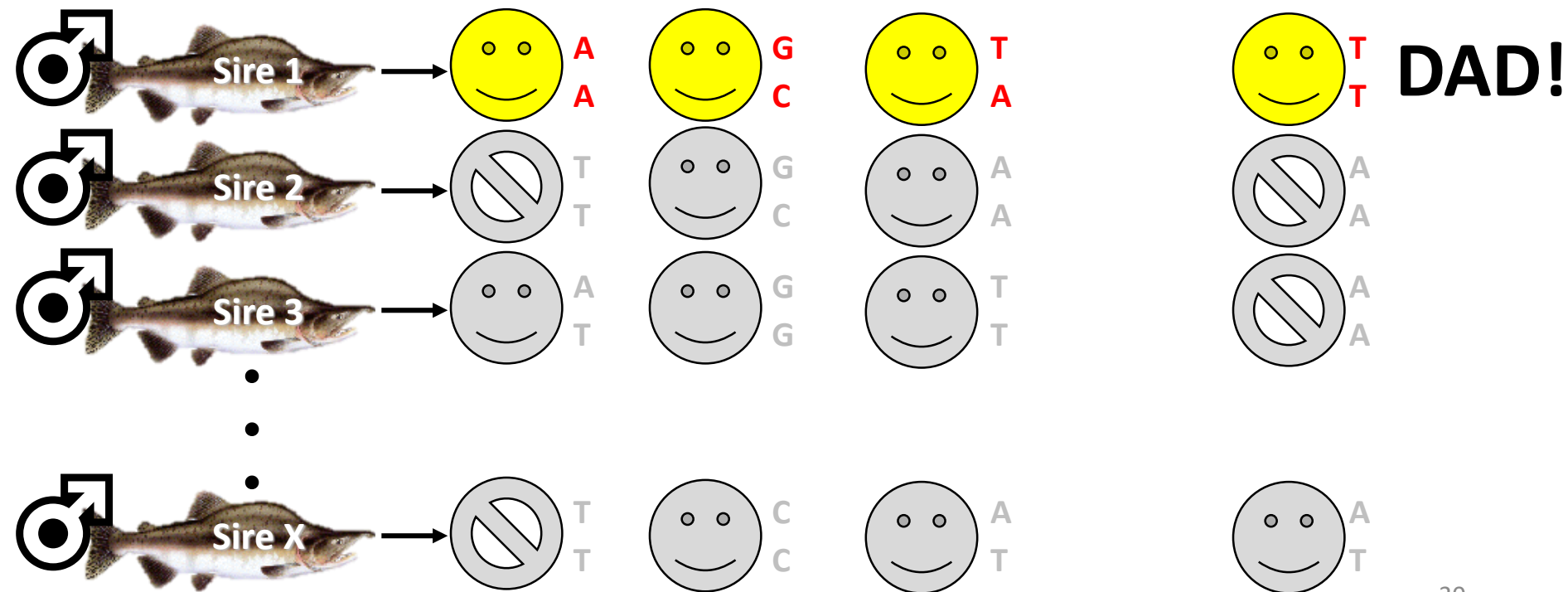

Measuring Reproductive Success

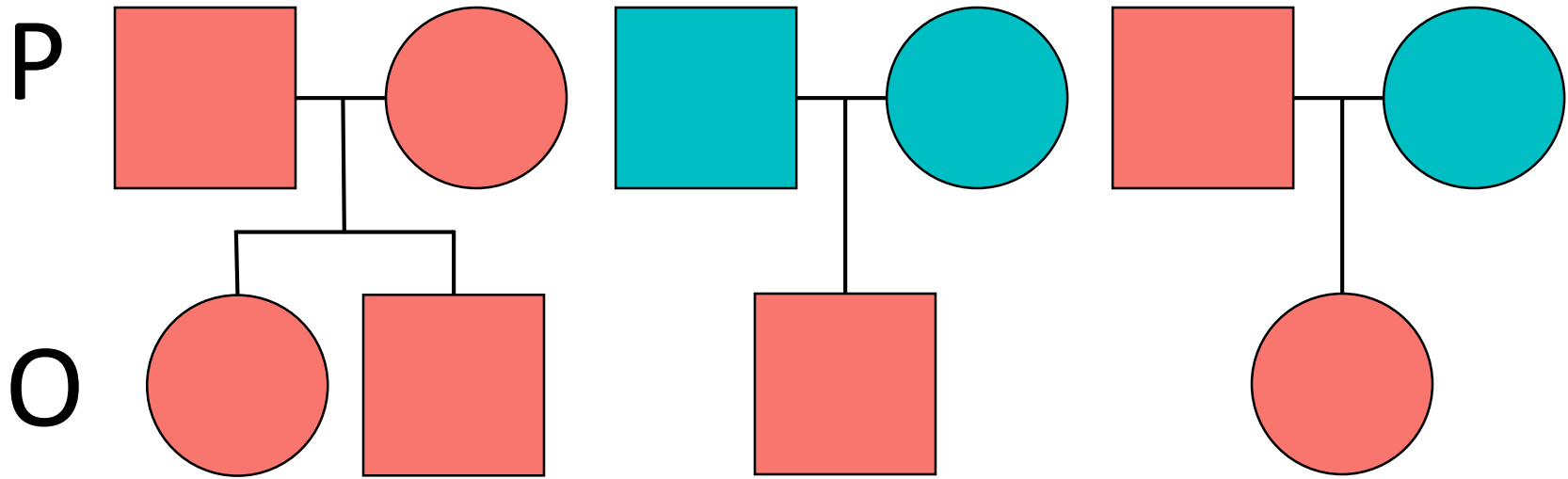

Natural Hatchery

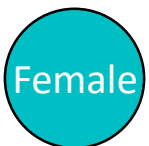
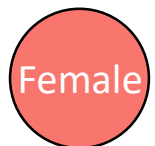
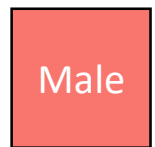

Measuring Reproductive Success

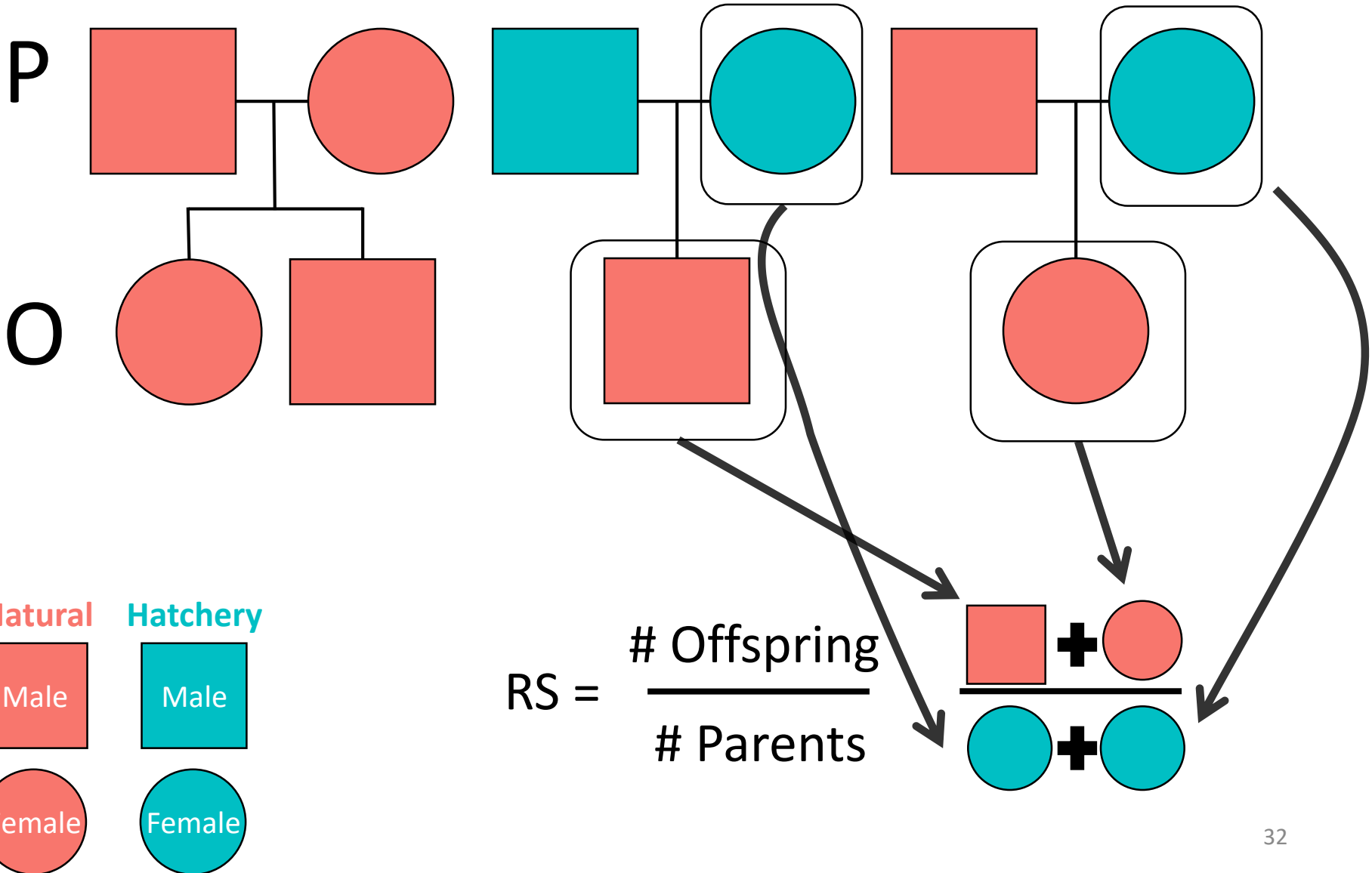

Measuring Reproductive Success

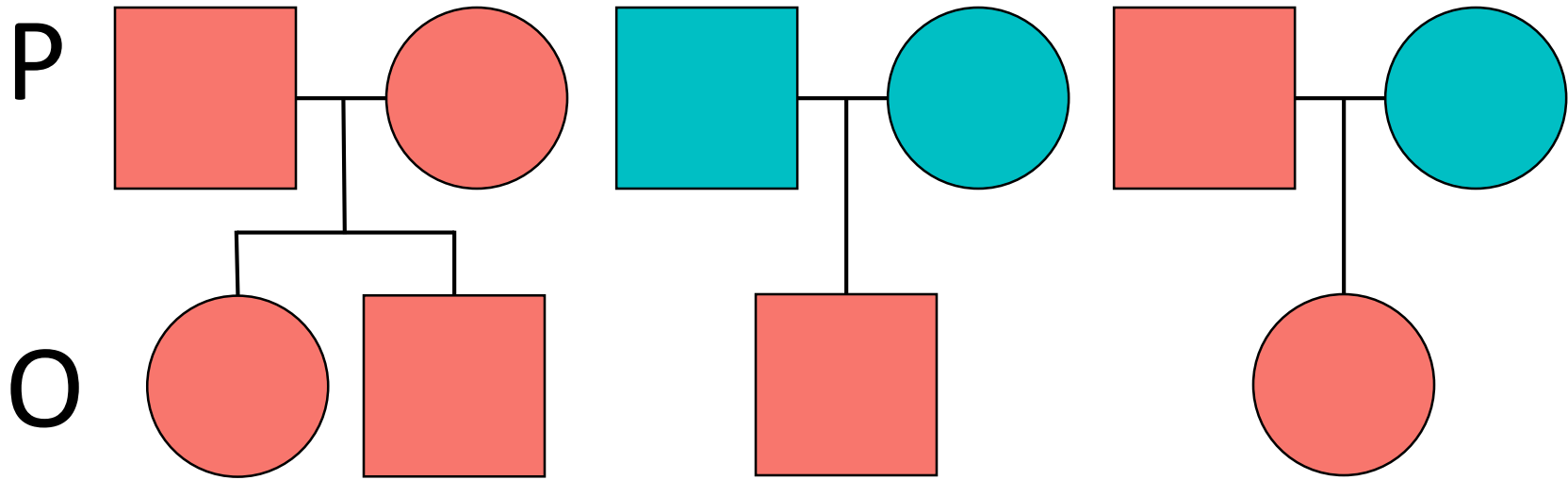

$$RS_{H \text{ Female}} = 1$$

Natural Hatchery

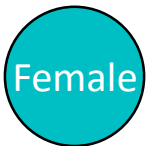
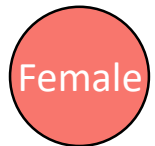
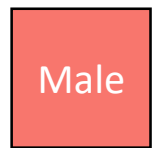

Measuring Reproductive Success

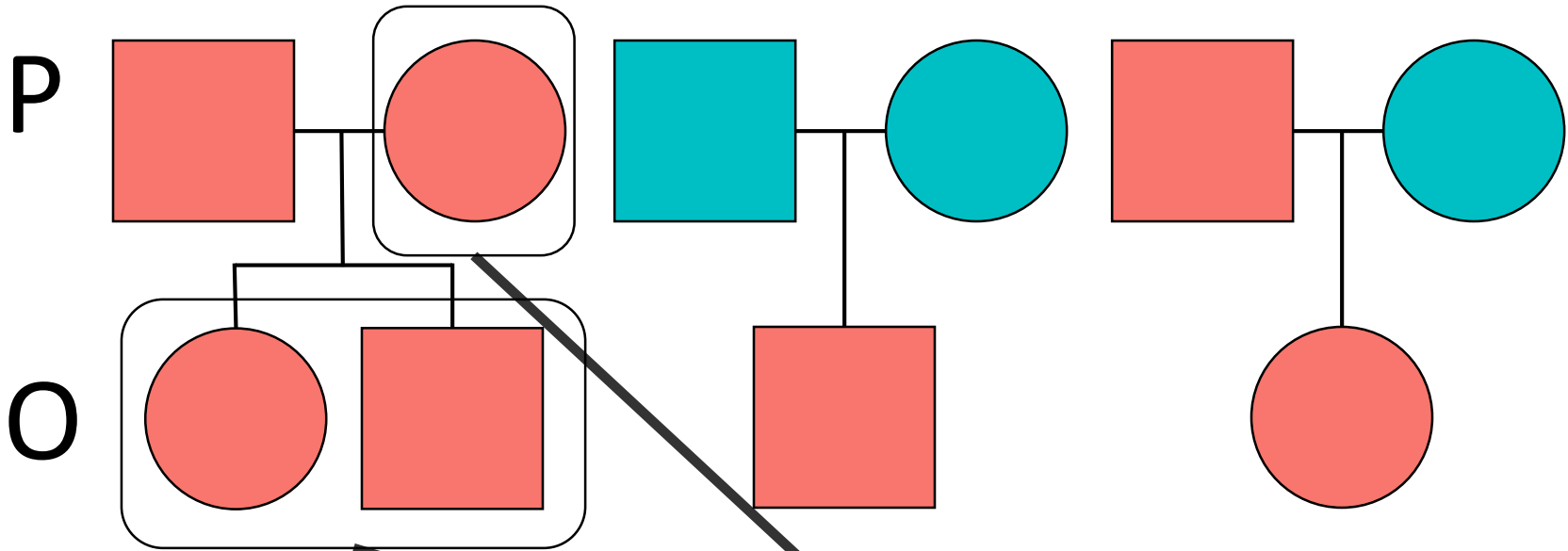

Natural **Hatchery**

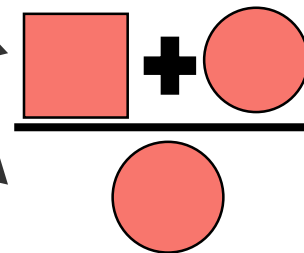
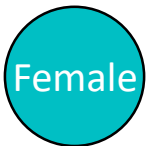
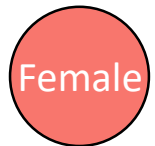
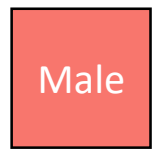

Measuring Reproductive Success

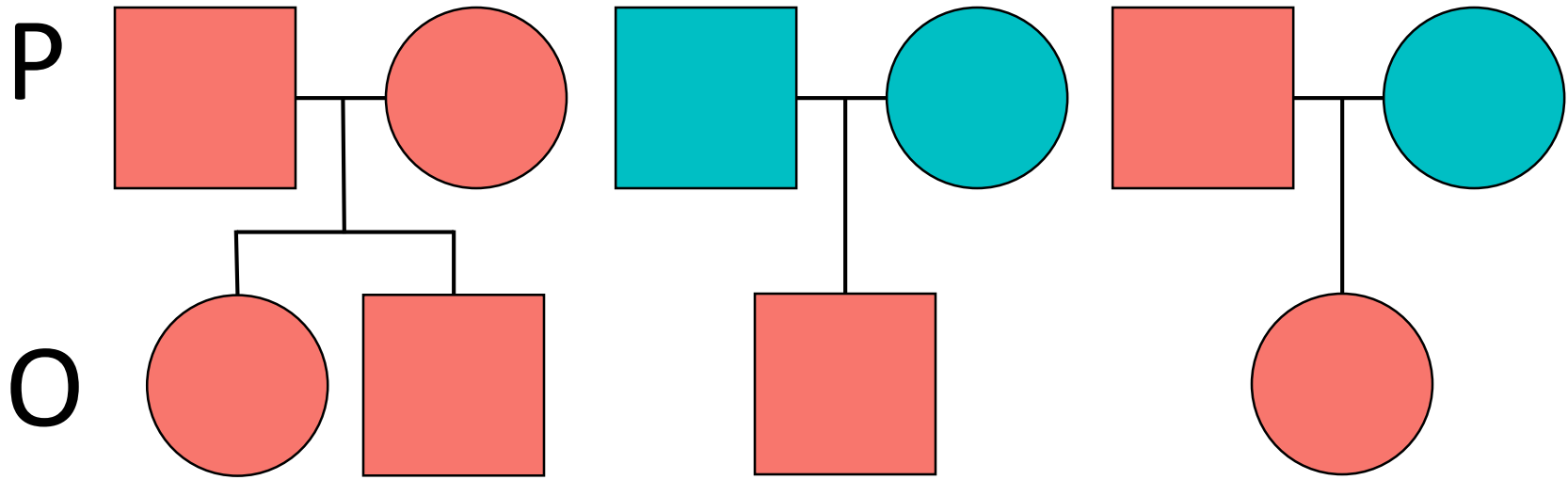

$$RS_{N \text{ Female}} = 2$$

$$RS_{H \text{ Female}} = 1$$

Natural Hatchery

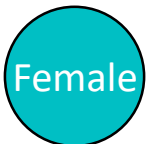
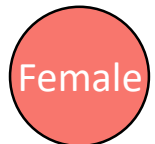
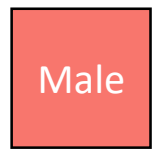

Measuring Reproductive Success

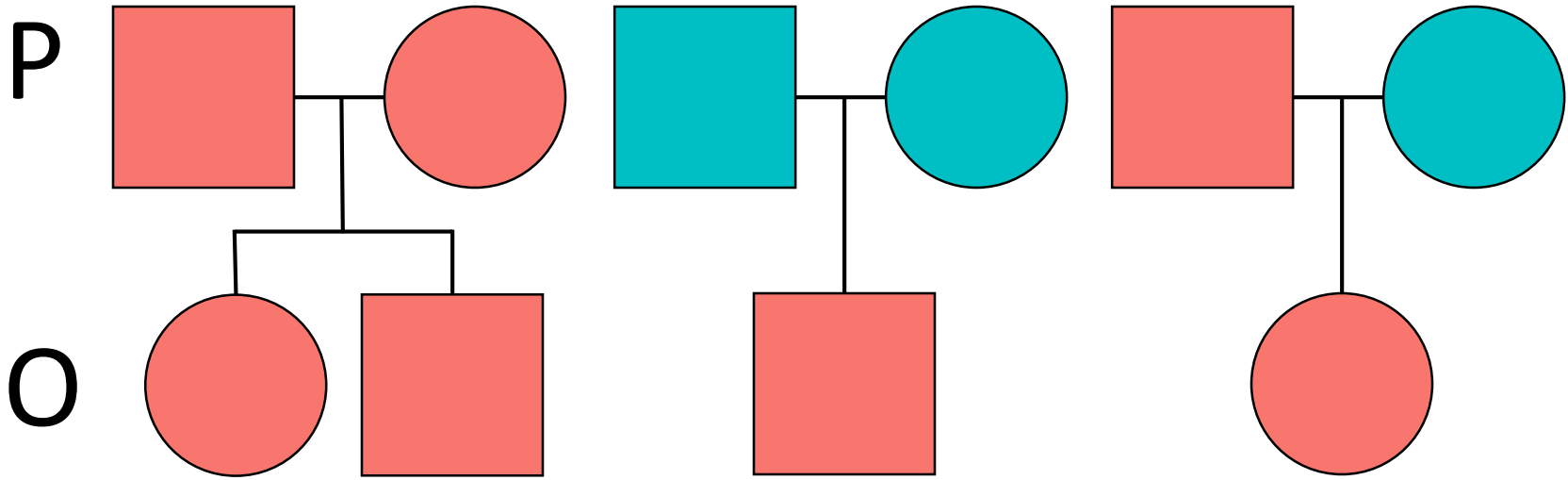

$$RS_{N \text{ Female}} = 2$$

$$RS_{H \text{ Female}} = 1$$

Natural Hatchery

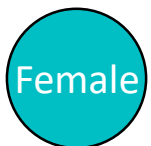
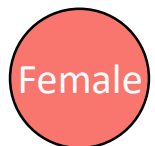
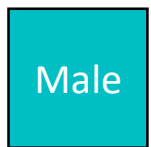

Relative Reproductive Success (RRS)

$$RRS = \frac{1}{2} = 0.5$$

Measuring Reproductive Success

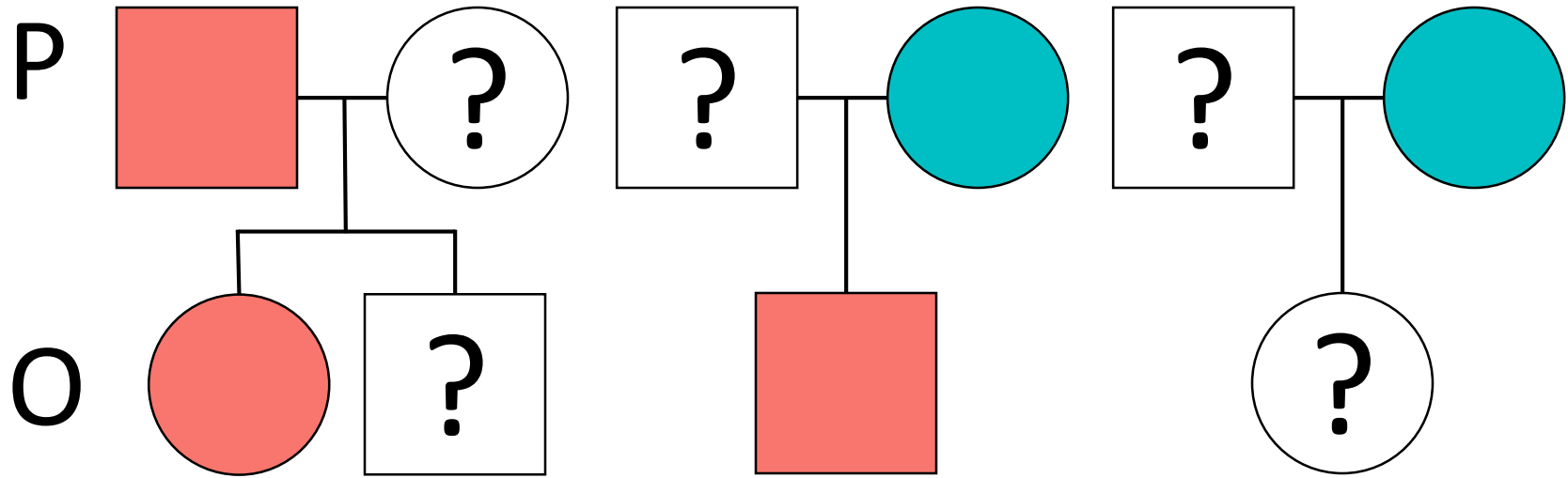

Natural Hatchery

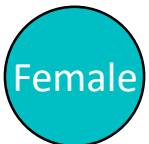
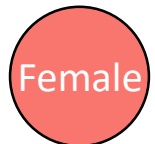

Relative Reproductive Success (RRS)

$$RRS = \frac{\overline{RS}_{\text{Hatchery}}}{\overline{RS}_{\text{Natural}}}$$

Average Reproductive Success

Stockdale 2014/2016

Female	2014	2016	Average RS	RRS
	Parents	Offspring		
Hatchery	230	196	0.85	= 0.42
Natural	221	448	2.03	

Male	2014	2016	Average RS	RRS
	Parents	Offspring		
Hatchery	206	177	0.86	= 0.28
Natural	137	417	3.04	

RS Distribution: Stockdale 2014/2016

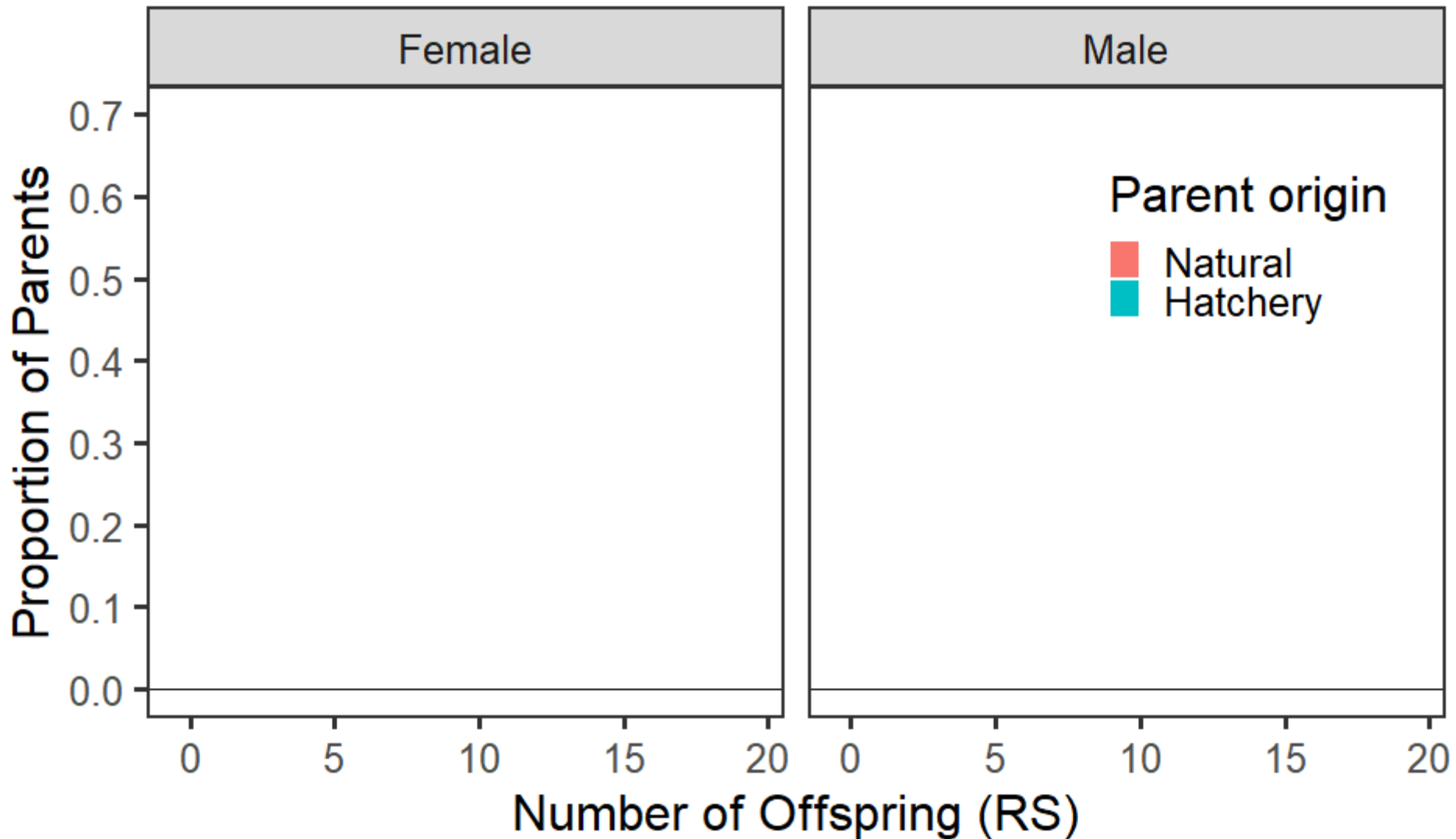

RS Distribution: Stockdale 2014/2016

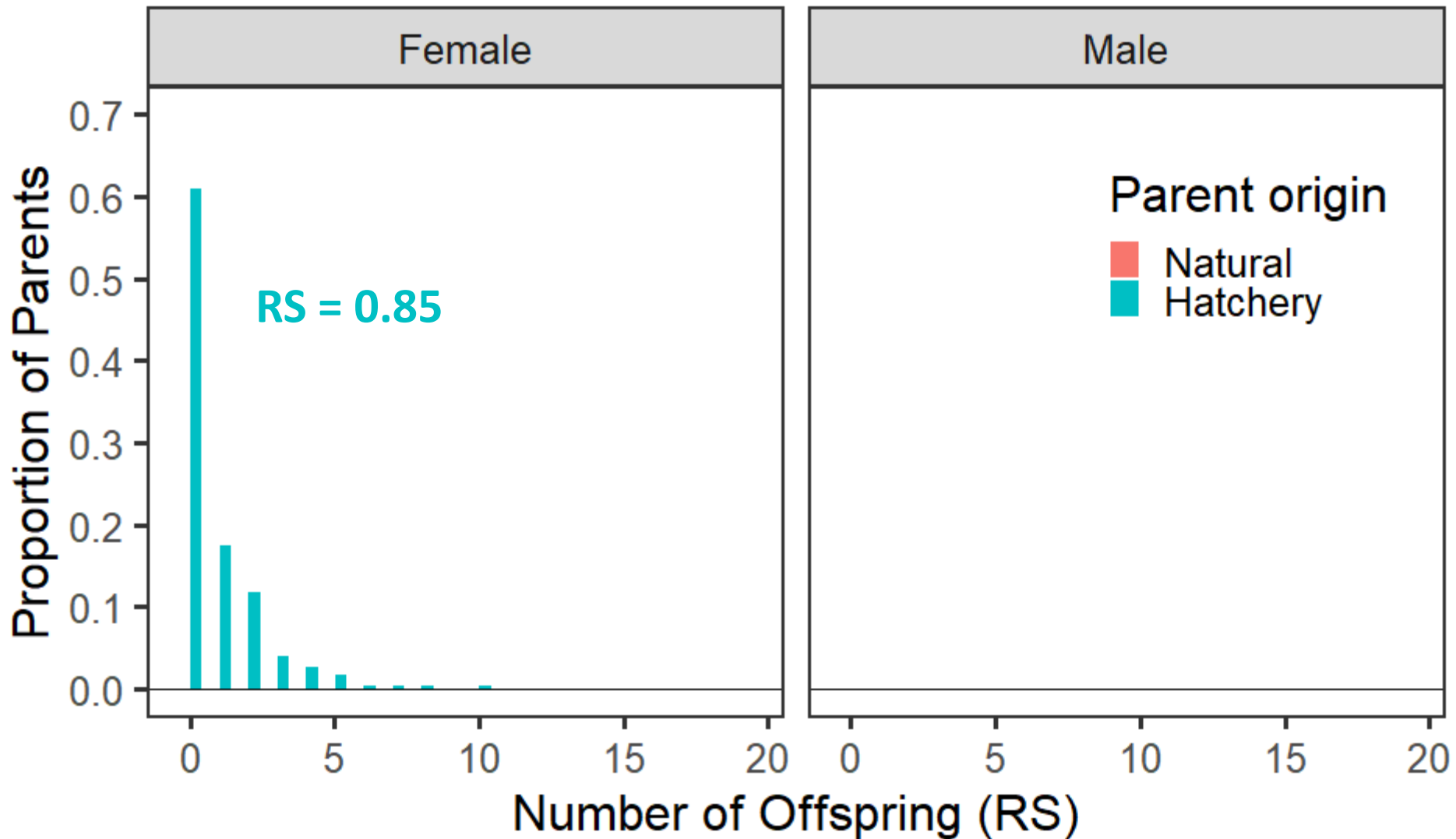

RS Distribution: Stockdale 2014/2016

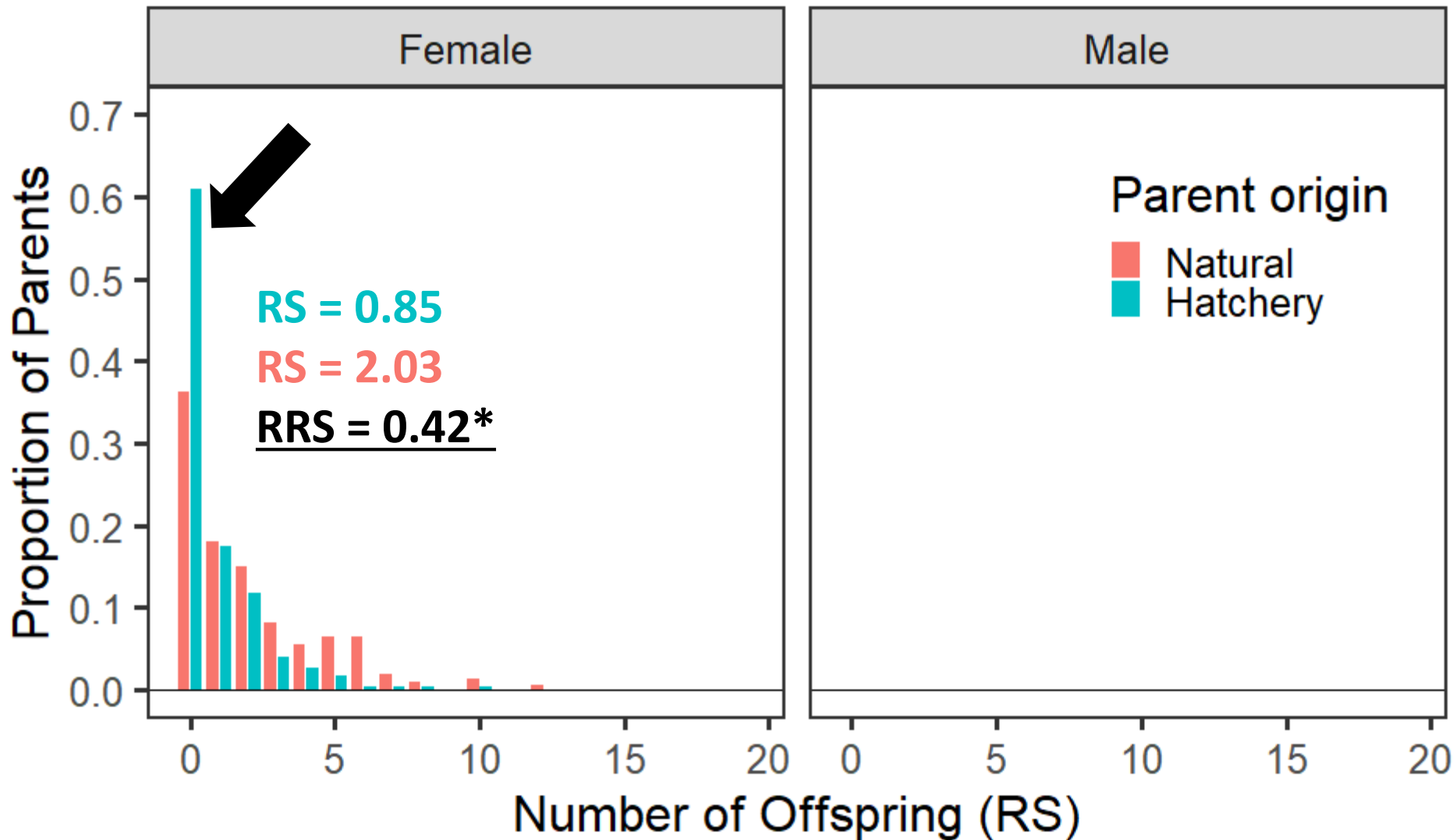

RS Distribution: Stockdale 2014/2016

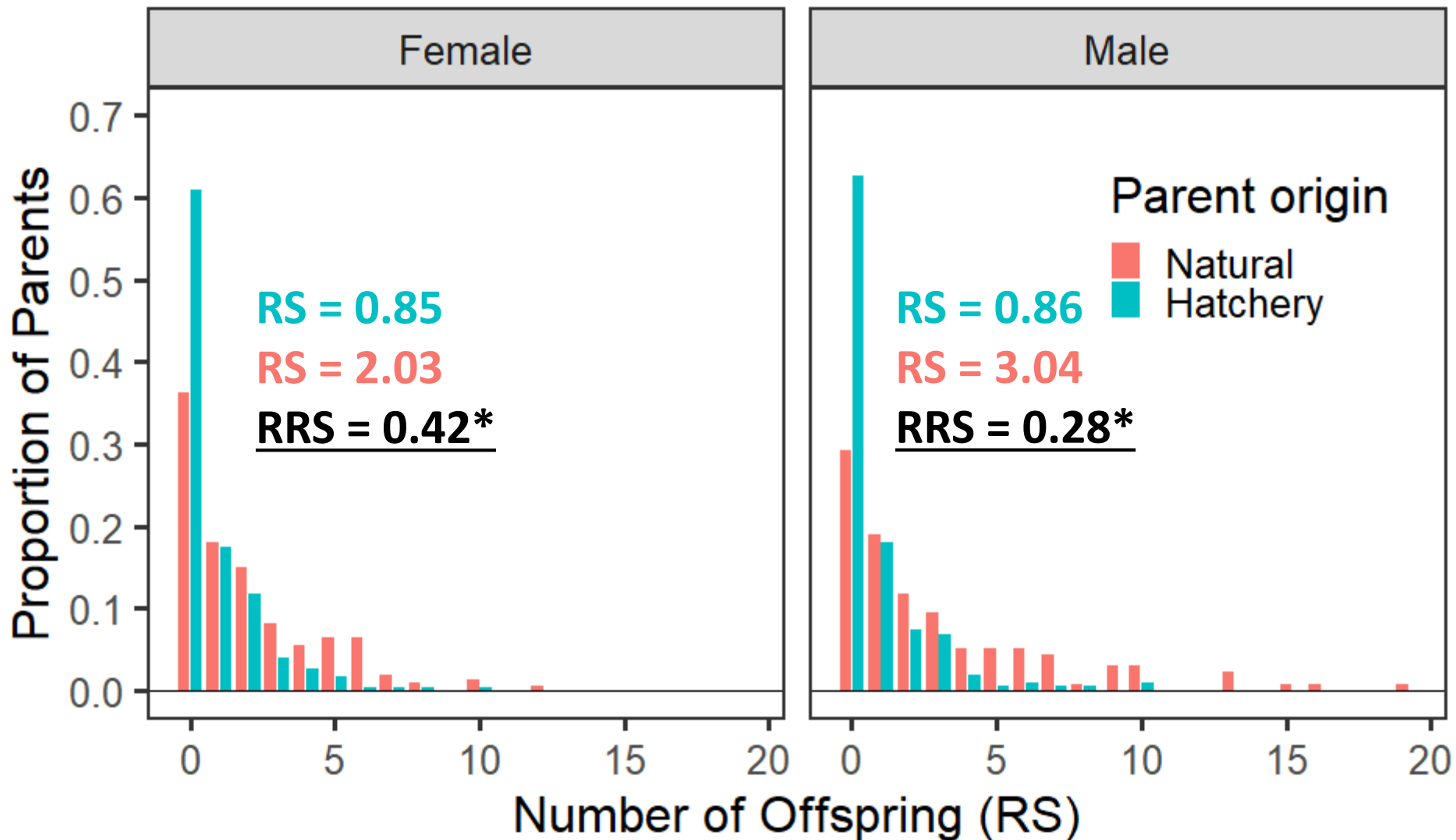

Parent-Offspring Duos

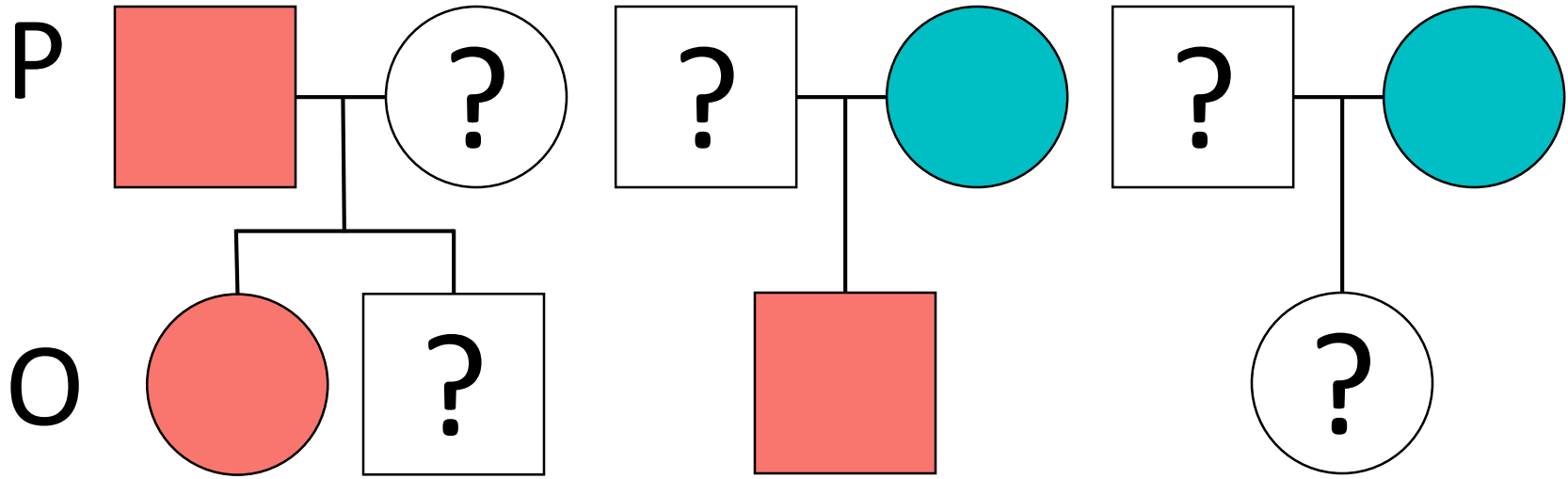

Natural Hatchery

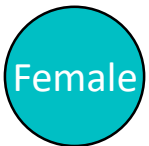
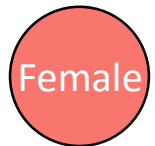
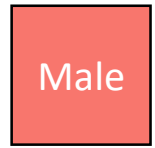

Parent-Offspring Trios

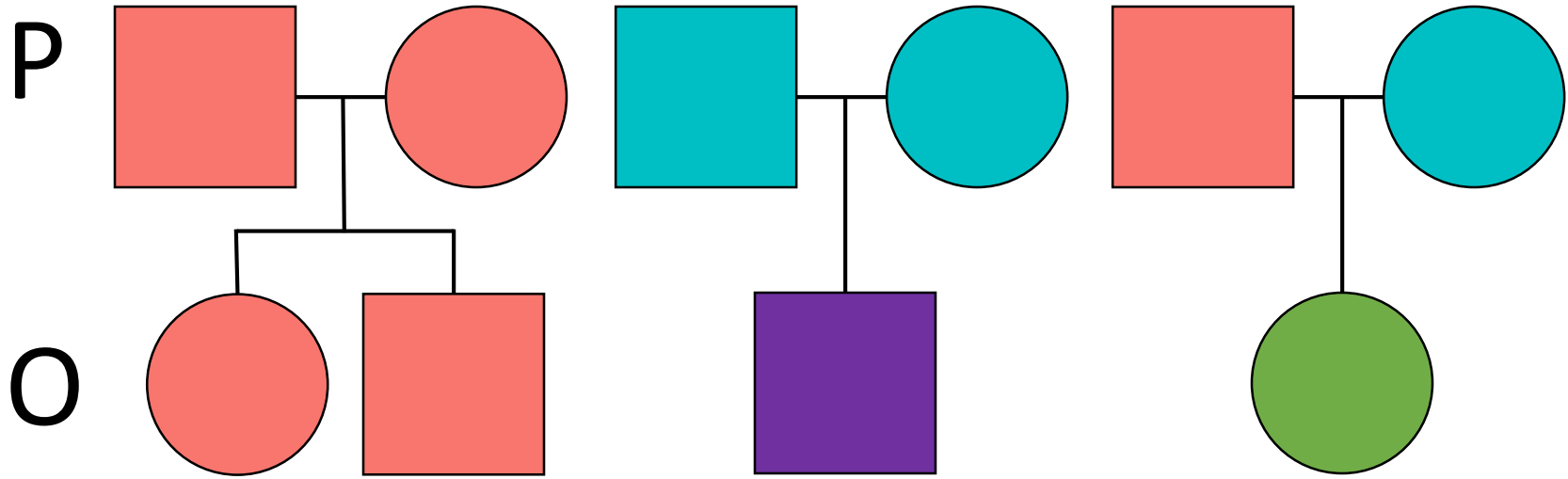

Natural Hatchery

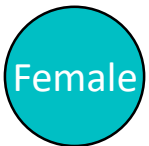
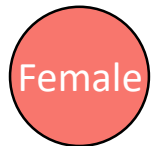
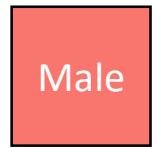

RS Distribution: Stockdale 2014/2016

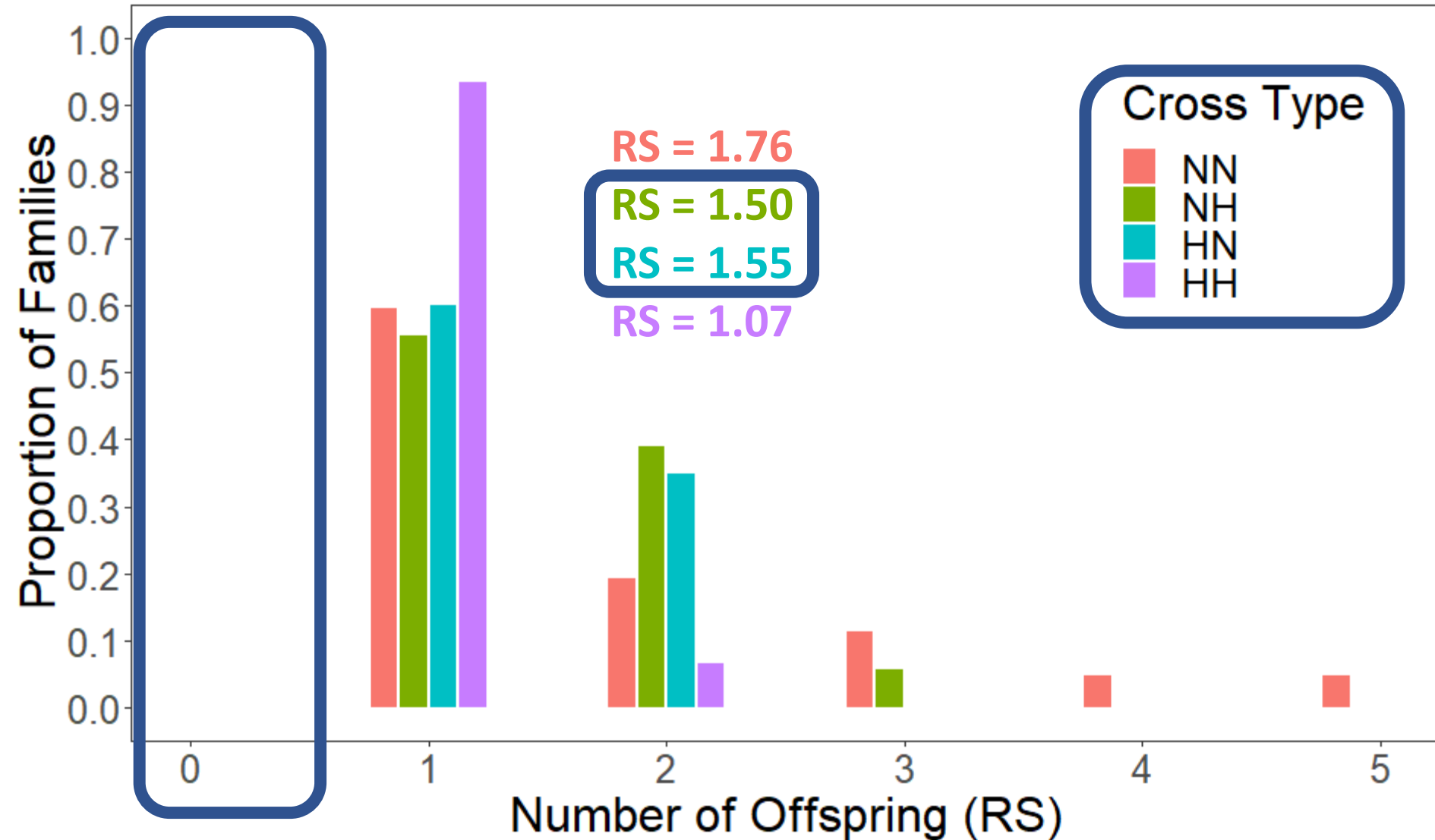

Summary of RRS to Date

Year	RRS (95% CI)	
	Hatchery / Natural	
	Male	Female
13/15	0.05 (0.01-0.17)	0.03 (0.01-0.08)
14/16	0.86 (0.67-1.12)	0.47 (0.37-0.62)
15/17	0.16 (0.09-0.25)	0.17 (0.10-0.26)

Year	RRS (95% CI)	
	Hatchery / Natural	
	Male	Female
13/15	0.69 (0.31-1.35)	0.17 (0.03-0.55)
14/16	0.28 (0.24-0.34)	0.42 (0.35-0.50)
15/17	0.66 (0.46-0.93)	0.41 (0.29-0.58)

Results in Context

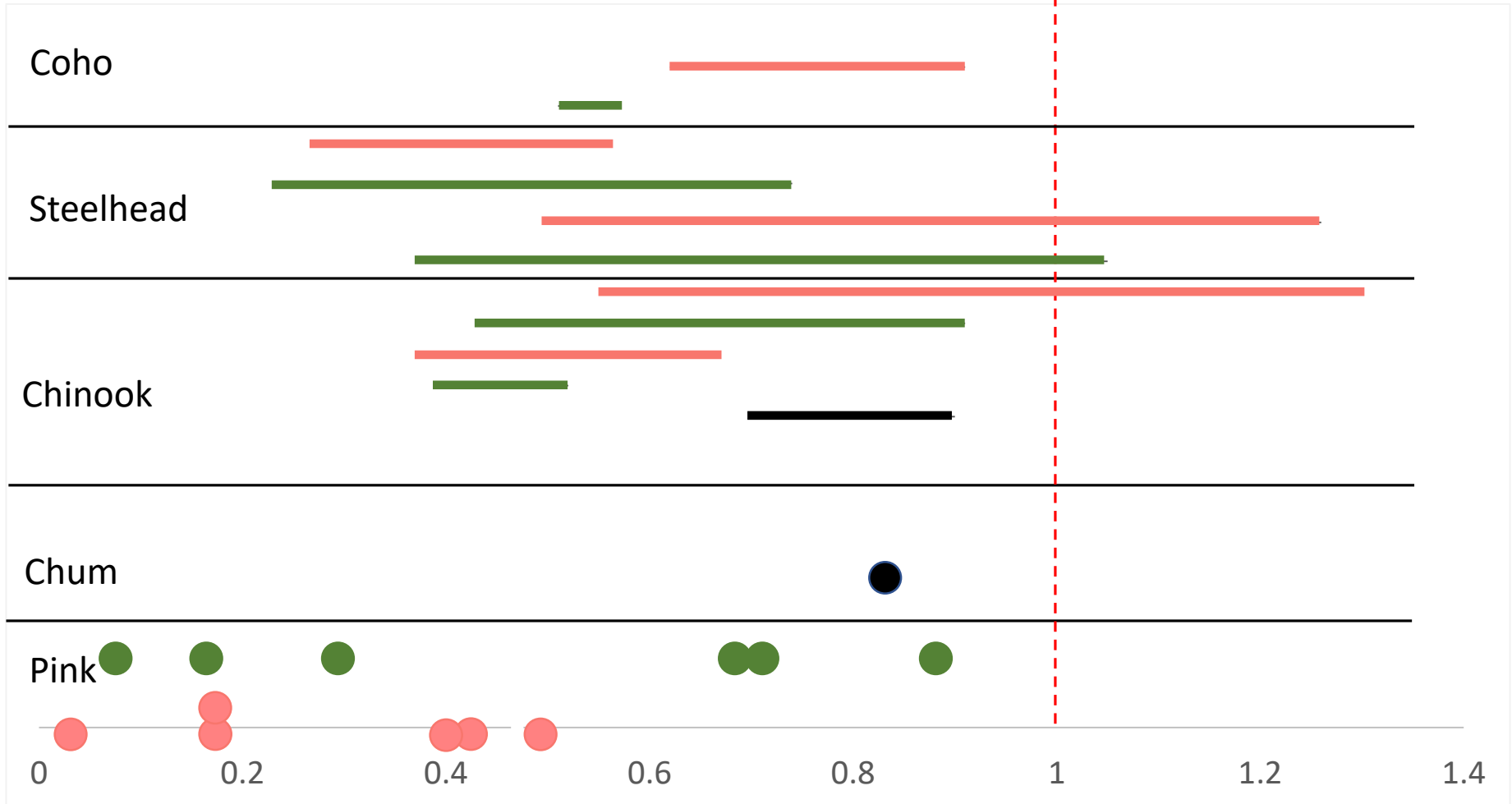
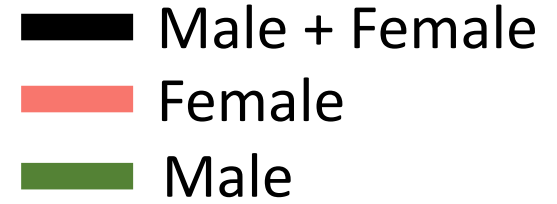

Grandparentage: Hogan 13/15/17

	hatchery	natural
P, 2013	442	321
O, 2015	6	104
G, 2017	0	5

Grandparentage: Stockdale 13/15/17

	hatchery	natural
P, 2013	163	811
O, 2015	10	119
G, 2017	3	19

Accounting for Other Factors

- Differences between hatchery/natural
 - Body length
 - Sample date
 - Sample location
- Correlated with number of offspring (RS)
- After accounting for these other factors (GLM), differences in RS remained (RRS ~ 42-60%)

Takeaways

- On average, hatchery-origin pink salmon that stray into the two streams for BY 2013-2015 consistently produce fewer adult offspring that return to their natal streams
- High variability in RRS (streams, years, sexes)
- After accounting for other variables (length, timing, location), hatchery-origin fish produce fewer offspring, on average, than natural-origin fish
- Hybrids had intermediate RRS
- Submitted for peer reviewed publication at *Evolutionary Applications* on 1/27/20

Remaining Questions

- Are observed reductions in hatchery-origin fitness an artifact of the study design?
 - Returning adults that are harvested?
 - Returning adults that stray to other streams?
- Are results consistent in other streams and years?
- Do hatchery/natural hybrids consistently produce fewer offspring than two natural-origin pink salmon?
- Are reductions in fitness persistent across generations (grand-offspring and beyond)?

Remaining Work

Stream	2013	2014	2015	2016	2017	2018	2019	2020
Hogan	P	P	P,O	P,O	P,O,G	O,G	O,G	
Stockdale	P	P	P,O	P,O	P,O,G	O,G	O,G	
Gilmour		P	P	P,O	P,O	O,G	O,G	
Paddy	P	P	P,O	P,O	O,G	P,O,G		O,G
Erb	P	P	P,O	P,O	O,G	P,O,G		O,G

P – parents

O – offspring

G – grand-offspring

Odd-lineage

Even-lineage

Acknowledgements

- Alaska Hatchery Research Program
 - State of Alaska
 - Seafood industry
 - Private non-profit hatcheries
- North Pacific Research Board (Project #1619)
 - Funding for Hogan Bay analyses (2013-2016)
- Saltonstall-Kennedy (NA16NMF4270251)
 - Funding for Stockdale analyses (2014/2016)
- Prince William Sound Science Center
 - Field collection
- ADF&G Cordova Otolith Lab
- University of Washington - Seeb Lab
- ADF&G Gene Conservation Laboratory



A large group of salmon swimming in a river, with the word "Questions?" overlaid in white text. The fish are in various stages of spawning, with some showing bright colors and others with their mouths open. The background shows a rocky riverbed and a forested hillside.

Questions?

AHRP Fitness Study: SEAK Chum Salmon

Map of SEAK Chum fitness streams

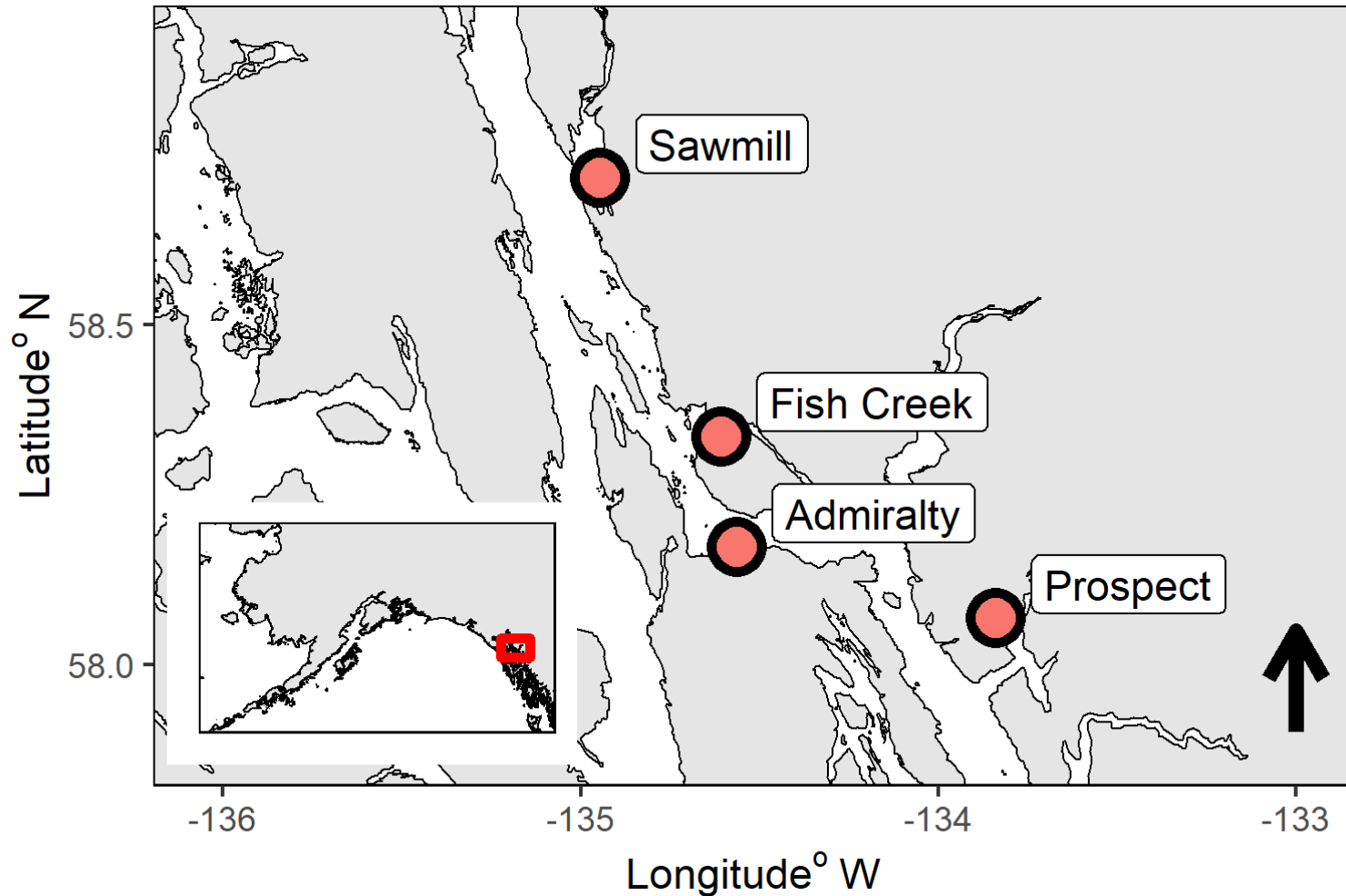

Study plan

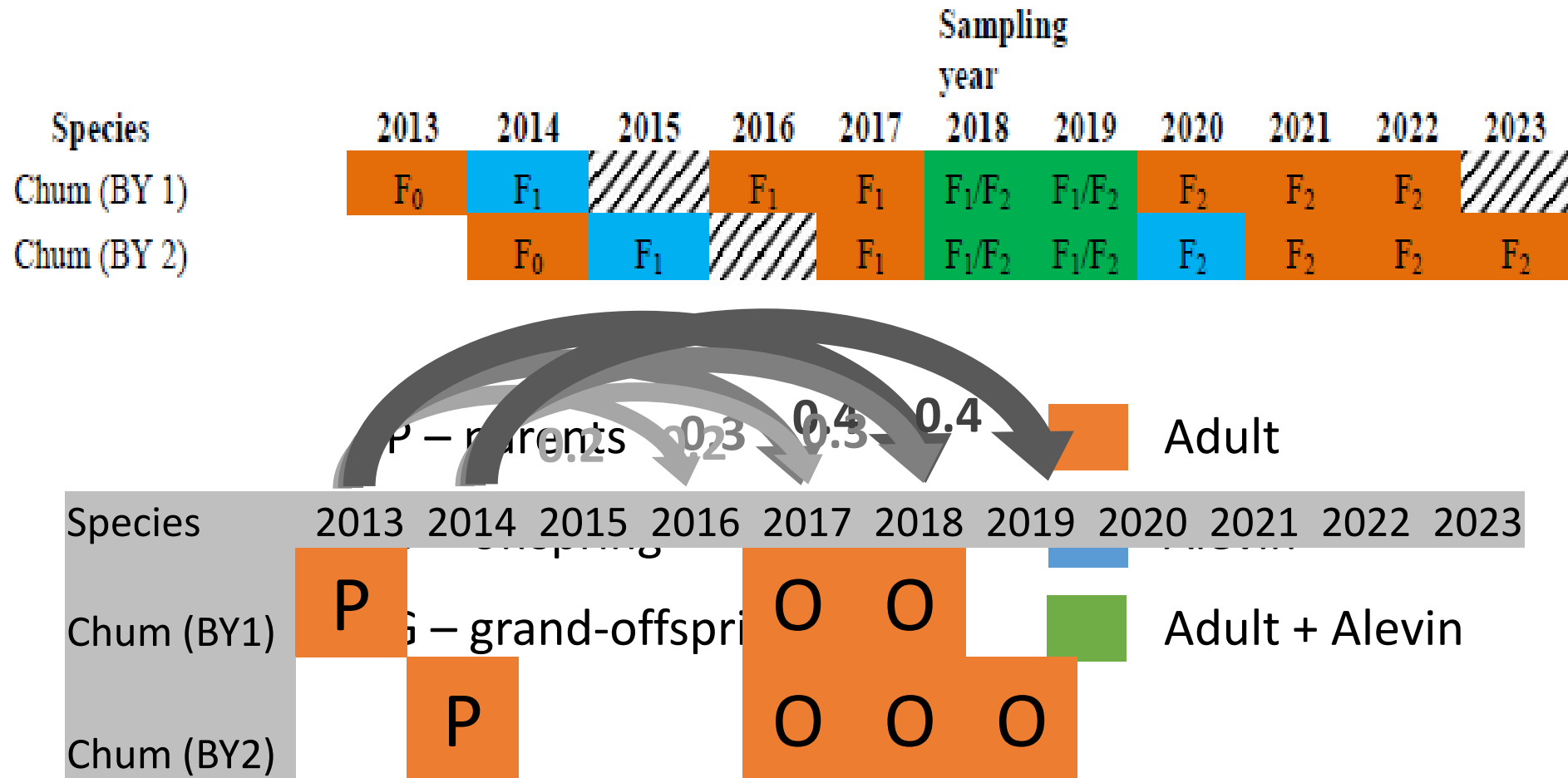

Statistical power of study plan

- Need minimum ~100 parents of each sex/origin
- Ideally a high proportion of parents
 - Hogan Bay 2013/2015
 - Low sampling rate = few parent-offspring assignments
- Sample high proportion of offspring
 - Consistent proportion for all return years
 - Differences in age at return?

Samples by origin, stream, and year

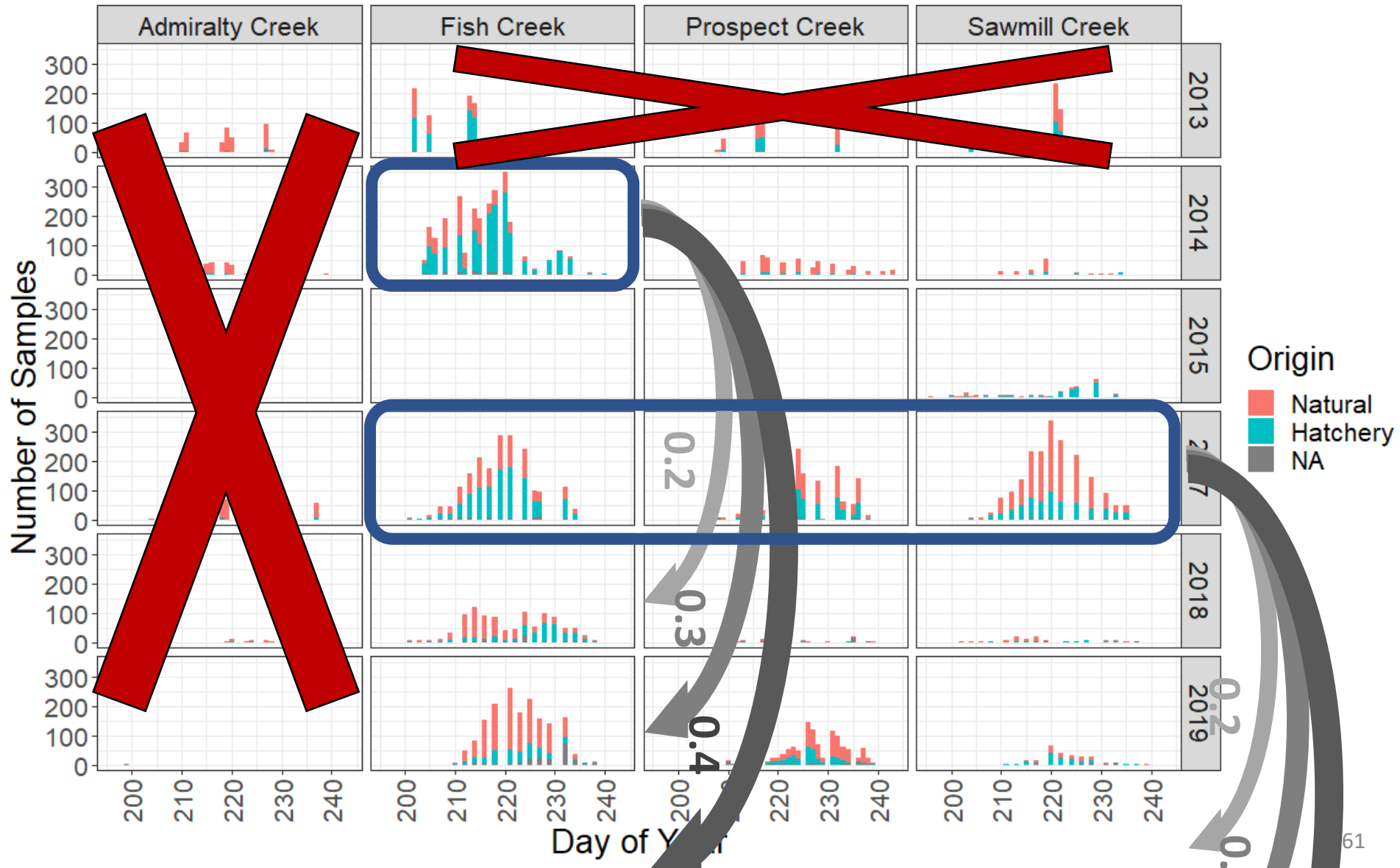

Acknowledgements

- Alaska Hatchery Research Program
 - State of Alaska
 - Seafood industry
 - Private non-profit hatcheries
- Sitka Sound Science Center
 - Field collection
- ADF&G Mark, Tag and Age Lab
- ADF&G Gene Conservation Laboratory



SITKA SOUND
SCIENCE CENTER



Questions?



